



LANGUAGES



INSTRUCTION MANUAL



KAGAMA ROLLER

Check that you have the latest version of this manual before each use.

Contrôlez avant chaque utilisation de ce manuel si vous en avez la dernière version.

Überprüfen Sie vor jedem Gebrauch dieses Handbuchs, ob Sie die neueste Version haben.

Controleer voor elk gebruik van deze handleiding of u over de laatste versie beschikt.



C-00474 Manual (V-2)

www.corally.com

WWW.CORALLY.COM

INTRODUCTION



Thank you for purchasing a Team Corally car. This manual describes the instructions for using the model and the electronic components. You will also find some tips on how to maintain your RC model so that you can enjoy it for years to come. You have purchased one of the most efficient models available on the market that has been designed by a team of professionals. You will also benefit from the best after-sales support. All Team Corally models guarantee a high quality of manufacture and performance that guarantees you a high satisfaction of use and services provided by the Team Corally. Always take the time to read the instructions carefully in order to follow all the procedures to use your RC model safely for you and for other people and property in the area. This will allow you to take full advantage of all the performance of your RC model.

Please also check the website www.corally.com/Downloads/ to check if you have the latest version of this instruction manual. (Version: see bottom cover of this manual)

If you have any questions about the model and its components, you can send a message to info@corally.com

We also recommend that you get help from an experienced model maker or your dealer.

You will find all the references of the spare parts on the website www.corally.com

TERM OF USE

The user is responsible for the use of your model. The user assumes all risks associated with the use of the model. This model is not intended for use by children under 14 years of age without the supervision of a responsible adult who is familiar with the dangers of using a RC model. Team Corally / JSP Group Intl bvba, its manufacturers, distributors and resellers cannot control the use and load of the model and therefore cannot be held responsible for any damage to property and damage caused to persons resulting from the use of this product. You must accept these conditions and consider yourself fully responsible for the use of this product. If not, do not use this product.

Due to the continuous development of our products, the exact specifications of the kit may vary. If you have a problem with your new kit, please contact the store where you purchased it, indicating the part number(s).

Team Corally / JSP Group Intl bvba reserves the right to change any specification without notice. All rights reserved.

READ FIRST

This owner's manual is designed for use with your vehicle and contains the instructions you will need to operate and maintain your vehicle.

- We know you want to start driving immediately after unpacking, but it is very important that you take the time to read this manual carefully, even if you are an experienced R/C driver.
- Read carefully and follow all instructions in this manual. Failure to comply with the instructions will be considered as abuse and/or negligence which may result in the cancellation of the warranty.
- Your vehicle is designed to operate on uneven terrain. However, dust, sand, water and carpet fibres can get into your car's work-spaces and can damage your vehicle if they are not removed quickly. We do not guarantee any warranty on your vehicle against damage caused by external elements such as sand, dirt or water. Users are responsible for the maintenance and safe operation of this vehicle.
- This product is not a toy. It is not suitable for users under 14 years of age, unless they are supervised by adults.
- Never attempt to disassemble electronic components. These have been carefully calibrated at the factory.
- Only improve your car with parts made for your car. If you upgrade performance, replace the entire system (such as the motor, inverter, battery, etc.) so that all components are properly adapted. Any malfunction resulting from a custom modification will void your warranty.
- Before driving your vehicle, please read this manual in its entirety and examine your vehicle and radio control system for any defects.
- For better performance, some adjustments may be necessary.
- This vehicle requires a battery (included in the car or in the packaging). Make sure the vehicle's battery is sufficiently charged before driving, otherwise you may lose control of the vehicle.
- The radio transmitter requires 4 AA batteries (not included)
- Always remove or disconnect the battery from the vehicle to the inverter when not in use.
- Please drive your car in a spacious place. Never drive your car on the street or in traffic. Public places are subject to specific legislation by country, city, municipality, please comply with the legislation for the use of RC models in your region.
- This product is fully assembled in the factory. We accept no liability for damage and/or accidents resulting from custom modifications and/or malfunctions.

SAFETY PRECAUTIONS

For your safety, always use wear gloves and goggles when assembling and maintaining your model.

Always take all necessary precautions when handling products (silicone oil, grease, thread lock, cyanolyte glue, fuel) for the operation of the model. (Refer to the manufacturer's instructions)

For your safety, to keep the warranty and obtain the best performance, always use original CORALLY genuine parts.

Contains: LEAD (CAS 7439-92-1) ANTIMONY (CAS 7440-36-0)

WARNING: This product contains a chemical known to the state of California to cause cancer and birth defects or other reproductive harm.

CAUTION: CANCER HAZARD

Contains lead, a listed carcinogen. Lead is harmful if ingested. Wash thoroughly after using.

DO NOT use product while eating, drinking or smoking.

USE PRECAUTIONS



Failure to operate your model in a safe and responsible manner may result in injury to yourself, others or damage to property around you.

- Do not use your model on public roads or in areas where you may encounter pedestrians or riders.
- Do not operate in a congested area or in crowds.
- Do not operate in areas where loud noises can disturb others, such as hospitals and residential areas.
- Do not operate your model with obstructed line of sight, at night or near water.
- Your model is radio controlled, it is subject to possible radio interference. Radio interference can cause loss of control of your model. Be careful.
- Take care not to injure yourself while using tools to adjust or upgrade your model.
- Since the model contains small parts, keep out of reach of children while assembling and/or disassembling your model.
- If your model becomes stuck against an object, release the throttle and retrieve it by hand
- Do not continue to apply the throttle when your model is stuck. This may damage the motor and/or ESC/ Receiver unit.
- Turn OFF your model and don't use it if it runs erratically. Please do not use your model again until the problem has been solved.
- Keep the wheels of the model off the ground when checking the operation of the radio equipment.
- When learning to operate your model, go to an area that has no obstacles that can damage your model.
- Before and after each use, check all the screws on the model.
- To maintain the best performance, check that all moving parts move freely.

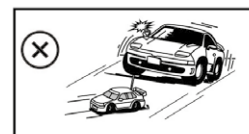

Take all necessary precautions before, during and after using your model. You are responsible for the safe assembly, maintenance and use of your model.

In case of any questions, contact your local reseller or contact Team Corally support for assistance.

LIPO BATTERY SAFETY PRECAUTIONS

- Follow and respect the manufacturer's instructions for use
- It is important to check that your ESC is set to LIPO if you are using a LIPO battery. Failure to comply with this instruction will result in increased battery discharge and may cause fire and damage to persons and property.
- When charging or storing LiPo batteries always use LiPo Safety Bag (Flame retardant).
- Always respect the maximum rate and voltage specified by the battery manufacturer.
- Charge the LIPO battery outdoors or in a ventilated area away from flammable objects and surfaces.
- NEVER leave your LiPo battery unattended while charging.
- If the battery swells during charging, stop charging immediately and disconnect the battery from the charger. Leave the battery outside for a few hours and observe. Then recycle the battery according to the instructions of your country/region. Never dispose of a LIPO battery with domestic waste.
- Before recycling your defective battery, it must be neutralized. Take a plastic container, fill it with water and add a lot of salt until the water becomes opaque. Place the LIPO battery in the water and leave for 24 hours. Check with a voltmeter that the voltage is 0.0V. Then recycle the battery according to local regulations.
- Never charge a damaged or inflated battery.
- Never discharge the battery cells below 3.2V.
- Always use the appropriate balancer/charger when charging your LiPo battery pack.
- When the battery is empty, check the temperature of the battery before charging it. If the battery is very hot, wait until it cools before charging it.
- Never charge a very hot battery as this may cause an explosion or fire.
- When the battery is empty, recharge it immediately. Do not store an empty battery, the battery will continue to discharge, it will fall below the minimum voltage and become unusable.

WARRANTY (All models)



If material defects or manufacturing faults should arise in a product distributed or manufactured by Team Corally / JSP Group Intl bvba, and purchased by a consumer, we Team Corally / JSP Group Intl bvba acknowledge the obligation to correct those faults or defects within the limitations described below. This manufacturer's warranty is in addition to, and does not affect, the legal or contractual rights of the consumer which arise from the purchase of such products. Team Corally / JSP Group Intl bvba guarantees the consumer that its products are free from material, manufacturing, and construction faults, as determined by the general state of knowledge and technology valid at the time of manufacturing. The fault responsible for causing the damage must be proven to have been present in the product at this time. Claims for compensation arising from consequential damage or product liability will not be considered valid unless they fall under peremptory provisions of the law. If material defects or manufacturing faults should arise in a product distributed or manufactured by Team Corally / JSP Group Intl bvba in the European community (EC) and purchased by a consumer, then Team Corally / JSP Group Intl bvba undertakes to correct those defects within the limitations described below. This manufacturer's declaration does not affect the consumer's legal or contractual rights regarding defects arising from the purchase contract between the consumer and the dealer or reseller. **Extend of the Warranty**

If a claim is made under warranty, we take at our discretion to repair or replace the defective goods. We will not consider supplementary claims, especially for reimbursement of costs relating to the defect (e.g. installation / removal costs) and compensation for consequent damages unless they are allowed by statute. This does not affect claims on legal regulations, especially according to the product liability law.

Provisions of the Warranty

The purchaser is required to make the warranty claim in writing, and must enclose original proof of purchase (e.g. invoice, receipt, delivery note) and the appropriate warranty card. He must send the defective goods to our local representatives or directly to Team Corally / JSP Group Intl bvba, Geelseweg 80, 2250 Olen, Belgium at his own risk and cost.

The purchaser should state the material defect or manufacturing fault, or symptoms of the fault, as accurate as possible, so that we can check if our warranty obligation is applicable. The goods are transported from the consumer to us, and from us to the consumer, entirely at the risk and cost of the consumer.

Invalidation of the Warranty

The consumer cannot make a claim under warranty when the fault is affecting the use of the product arising from natural wear, competition use, or improper use (including installation) or external forces. The consumer's adherence to the building and operating instructions relevant to the model, including the installation, operation, use of, and maintenance of, model-related components cannot be supervised by Team Corally / JSP Group Intl bvba. Therefore Team Corally / JSP Group Intl bvba is in no way liable for loss, damage, or costs resulting from improper use, or behaviour in any way connected to the above described provisions. Unless otherwise required by law, Team Corally / JSP Group Intl bvba is in no way whatever liable to provide compensation for damages arising from the improper use of the model (including personal injury, death, damage to buildings, loss of turnover, loss of business, or interruption of business, or any other direct, or indirectly caused, consequential damage).

Duration of Validity

The claim period is 24 months from the date of purchase of the product by the consumer from a dealer in the European Community (EC) counted from the date of purchase. The claim period is 12 months from the date of purchase of the product by the consumer from a dealer outside the European Community (EC) counted from the date of purchase. If a defect arises after the end of the claim period, or if evidence or documents required according to this declaration in order to make the claim valid are not presented until after this period, then the consumer forfeits any rights or claims from this declaration. The guarantee period is not prolonged by the granting of any claims within the framework of this warranty, especially in the case of repair or replacement. The guarantee period also does not restart in such cases.

Warranty Expiration

If we do not acknowledge the validity of a claim based on this declaration within the claim period, all claims based on this declaration will expire after six months from the time of registering the claim; however this cannot occur prior to the end of the claim period.

For any support, contact us at support.corally.com

DOWNLOAD - TELECHARGER - DOWNLOAD - DOWNLOAD



- Check the corally.com website download section and make sure you have the latest version of this manual (see date on the cover of the manual)
- Vistez le site web corally.com section téléchargement et controlez que vous avez la dernière version de ce manuel (voir date sur la couverture du manuel)
- Überprüfen Sie die Website corally.com im Download-Bereich und stellen Sie sicher, dass Sie die neueste Version dieses Handbuchs haben (siehe Datum auf dem Umschlag des Handbuchs).
- Kijk op de corally.com website in de download sectie en zorg ervoor dat u de laatste versie van deze handleiding heeft (zie datum op de omslag van de handleiding)

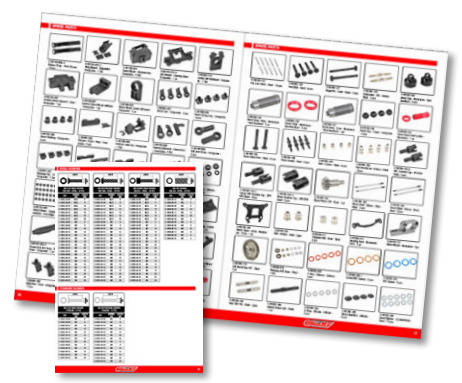
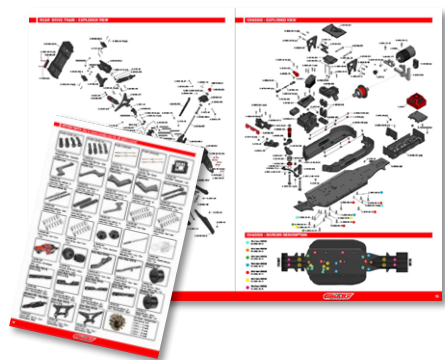

KIT CONTENT



C-00474-R

RTR Model - Electronics not included



C-00474-B



C-00474-G



Instruction Manual

REQUIRED FOR OPERATION (Not included)



2-Channel Remote Control System - 2.4GHZ



Recommended #C-52001

CS-5226 Servo
25.6Kg - 0.07 sec
Titanium Gears
Waterproof



Recommended #C-54011

TOROX 185 BLS Controller
2-6S - 150A
Sensorless
Waterproof



Recommended #C-54055

KURON 825 BLS Motor
4-POLE - 2050 KV
Sensorless

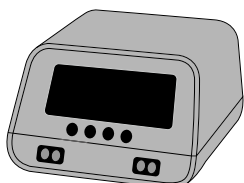

Charger

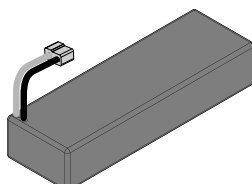

LiPo Battery 4-6S

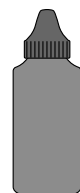

Silicone Oil
(Shocks - Differentials)



Silicone Oil
(Shocks - Differentials)



Cross Wrench

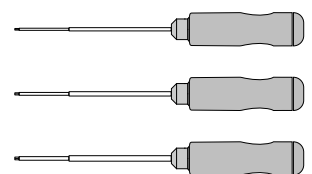

Hex Drivers 1.5 - 2.0 - 2.5 - 3.0

CAR COMPONENTS

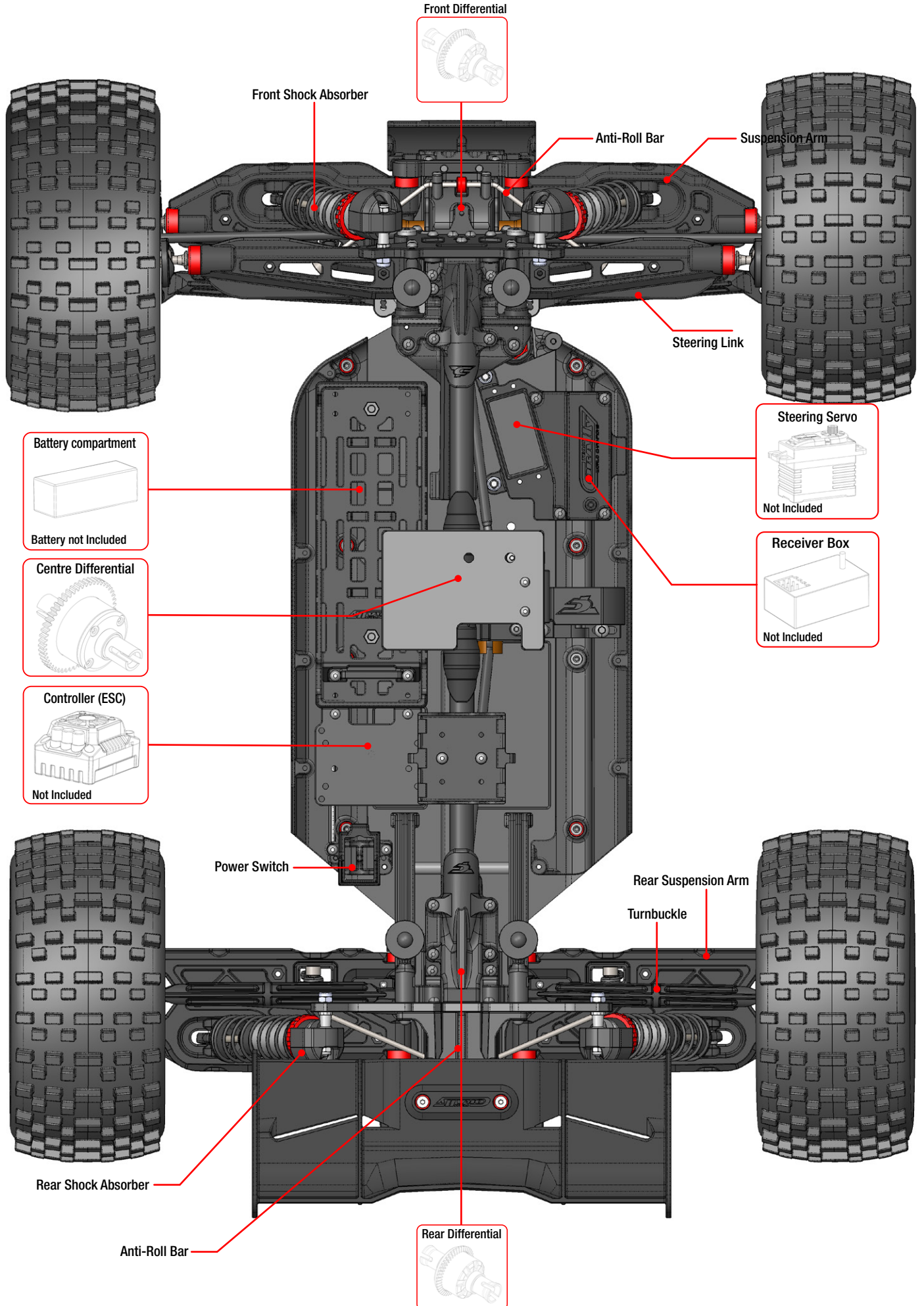

Electronics not included in kit

QUICK START GUIDE (General for all models)



READ THE INSTRUCTIONS



CHARGE THE BATTERY

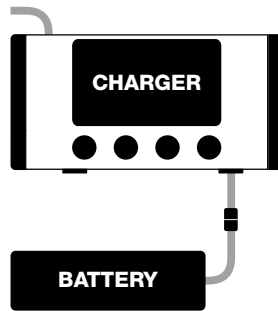

INSTALL 4x AA BATTERY - 1.5V



MAKE SURE THAT ALL SCREWS AND NUTS ARE TIGHTENED PROPERLY.

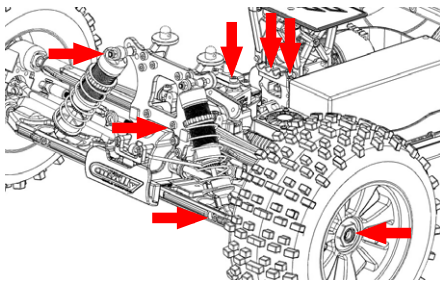

INSTALL THE BATTERY

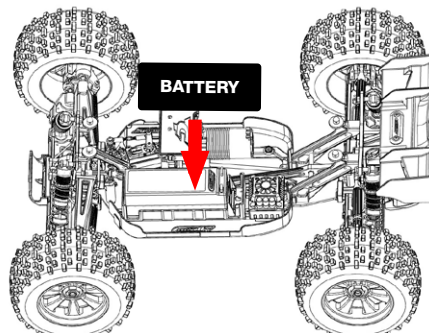

TURN ON THE TRANSMITTER (Always First)



CONNECT THE BATTERY TO THE ESC SWITCH ON THE ESC

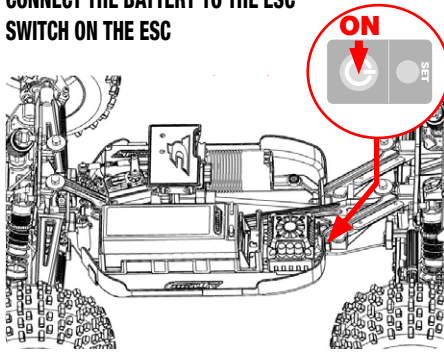

CHECK THE FUNCTIONS

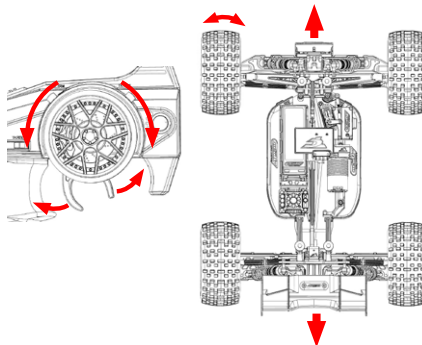

CHECK THE RADIO SYSTEM RANGE

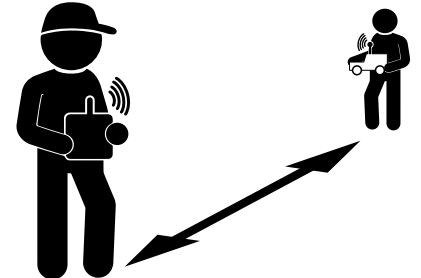

Move away from the max. distance you will drive the vehicle. Check that the vehicle responds properly to the controls. If not, reduce the distance or change the driving location.

DRIVE SLOWLY TO BEGIN

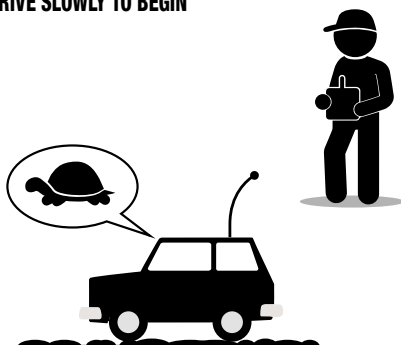

WHEN FINISHING

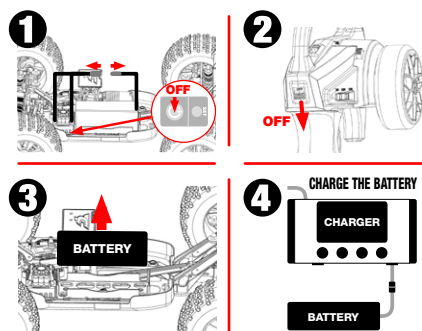

CLEAN AND MAINTAIN YOUR VEHICLE





1 SERVO INSTALLATION



Recommended Servo :
Digital Servo - CS-5226 - High Voltage
#C-52001

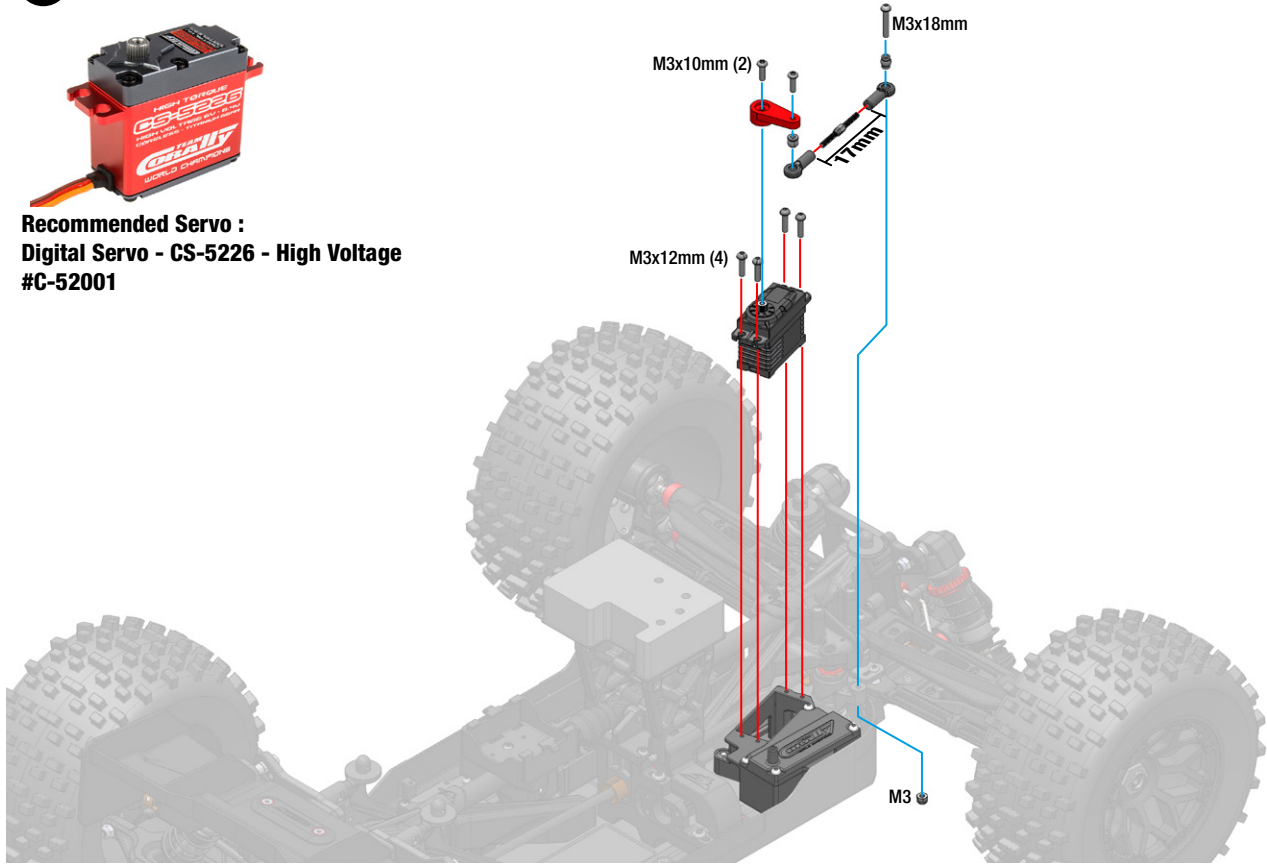

2 ESC INSTALLATION



Recommended ESC :
Speed Controller - TOROX 185 -
Brushless - 2-6S
#C-54011

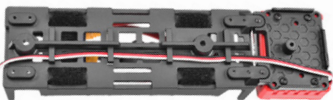

- Secure the ESC cable to the battery tray.
- Sécurisez le câble du ESC au support de batterie.
- Sichern Sie das ESC-Kabel an der Akkuhalterung.
- Maak de ESC-kabel vast aan de batterijhouder.

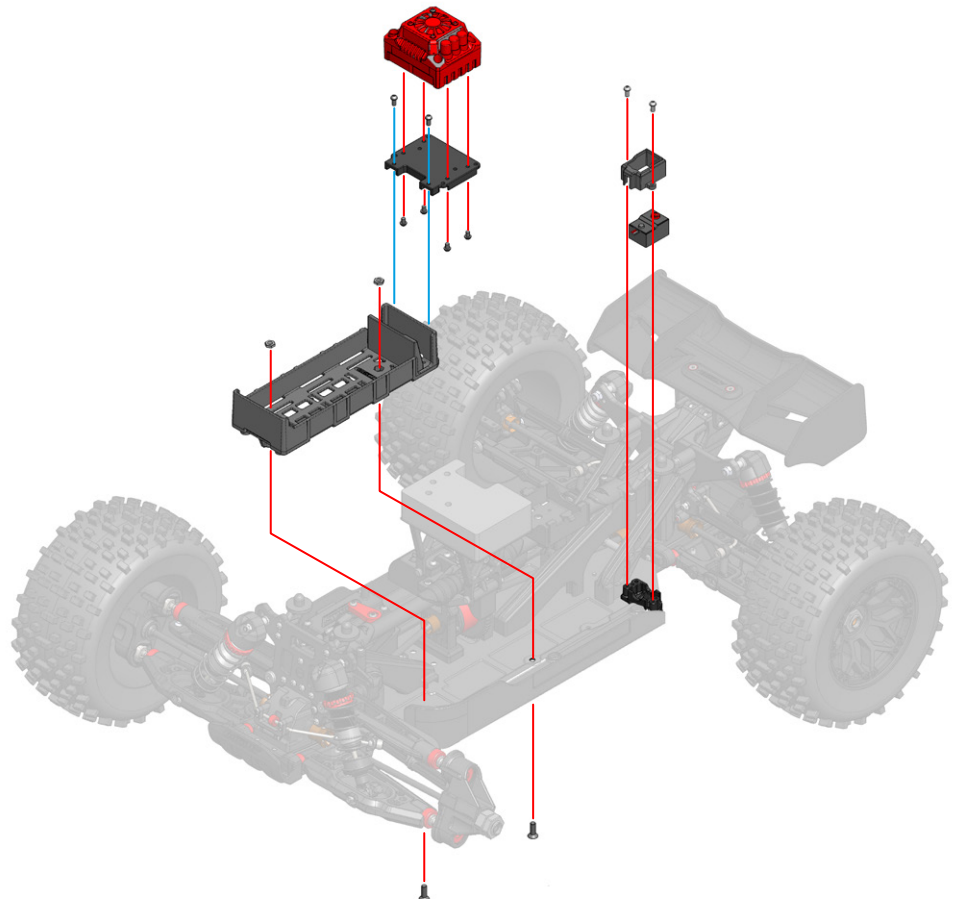



3 MOTOR INSTALLATION

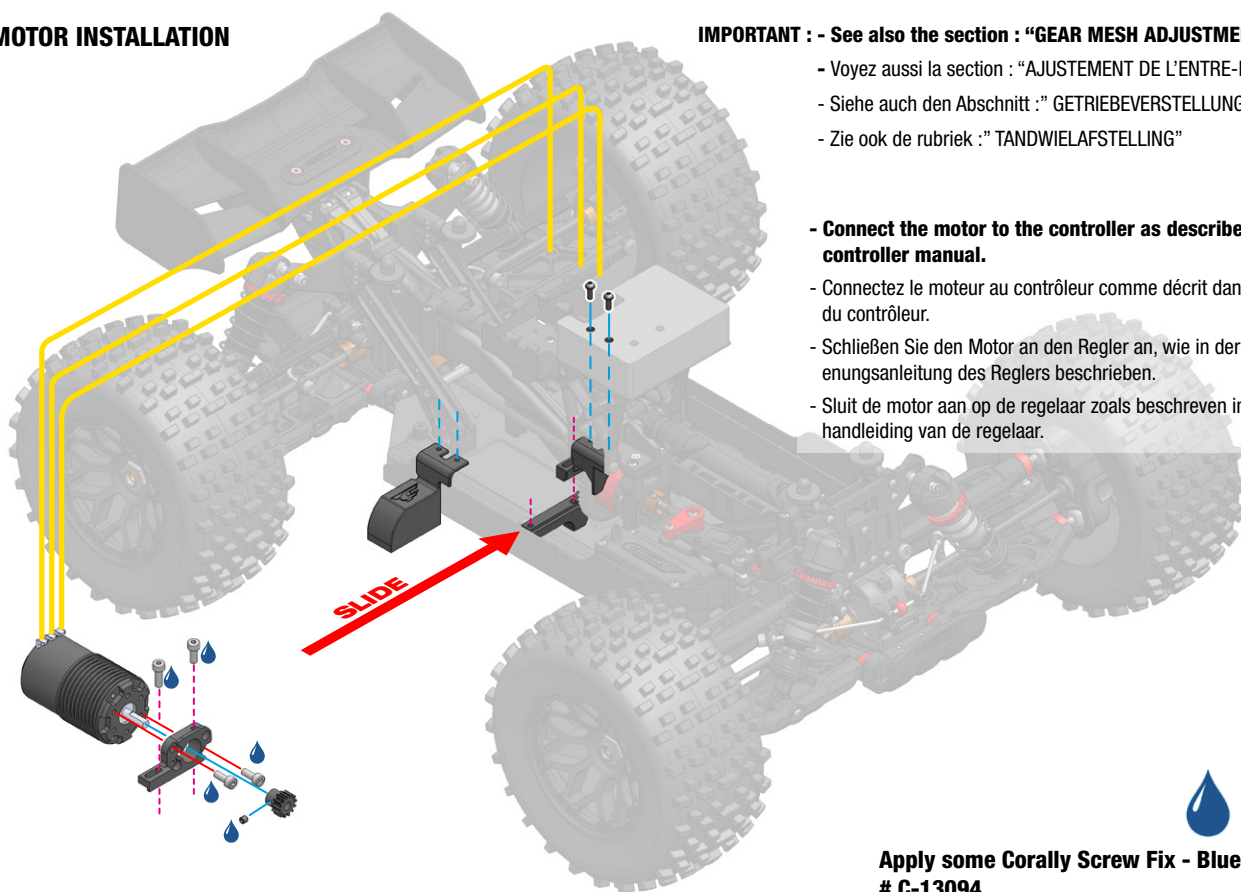

IMPORTANT : - See also the section : "GEAR MESH ADJUSTMENT"

- Voyez aussi la section : "AJUSTEMENT DE L'ENTRE-DENTS"
- Siehe auch den Abschnitt : "GETRIEBEVERSTELLUNG"
- Zie ook de rubriek : "TANDWIELAFSTELLING"

- Connect the motor to the controller as described in the controller manual.

- Connectez le moteur au contrôleur comme décrit dans le manuel du contrôleur.
- Schließen Sie den Motor an den Regler an, wie in der Bedienungsanleitung des Reglers beschrieben.
- Sluit de motor aan op de regelaar zoals beschreven in de handleiding van de regelaar.

Apply some Corally Screw Fix - Blue # C-13094



4 RECEIVER INSTALLATION

- Connect the servo cable to channel 1 of the receiver.
- Connect the ESC cable to channel 2 of the receiver.

- Connectez le câble du servo au canal 1 du récepteur.
- Connectez le câble de l'ESC au canal 2 du récepteur.
- Schließen Sie das Servokabel an Kanal 1 des Empfängers an.
- Schließen Sie das ESC-Kabel an Kanal 2 des Empfängers an.
- Sluit de servokabel aan op kanaal 1 van de ontvanger.
- Sluit de ESC-kabel aan op kanaal 2 van de ontvanger.

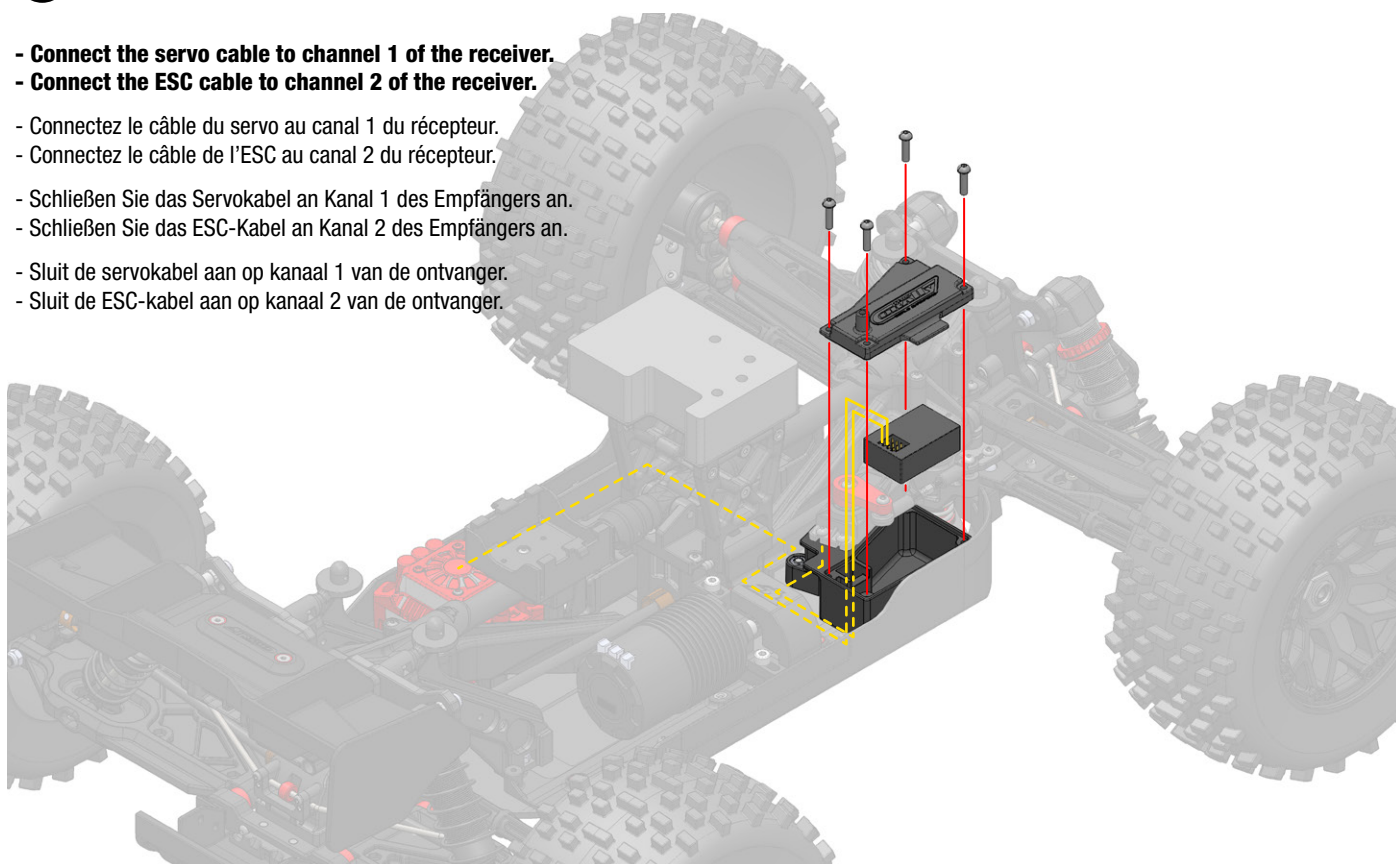

MOTOR PINION MOD1.0 - PIGNON MOTEUR MOD1.0 - MOTORRITZEL MOD1.0 - MOTOR PINION MOD1.0



High-performance pinions gear, manufactured from special steel for toughness and durability with precise tolerances and assures unparalleled concentricity. Created on a special gear machine, all pinions feature ultra-precise tooth shaping and ultra-true running for vibration-free operation. Each pinion is marked with the tooth number for easy and quick identification. Fits all cars with MOD1 gears (1/8 Scale)



Pignons Haute Performance, fabriqué en acier spécial avec des tolérances précises pour garantir solidité, longévité et concentricité. Tous les pignons présentent une forme de dent ultra-précise pour un fonctionnement sans vibrations. Chaque pignon est marqué du nombre de dents pour une identification facile et rapide. Convient à toutes les voitures avec des transmissions MOD1 (Echelle 1/8)



Hochleistungs-Ritzel, hergestellt aus Spezialstahl mit präzisen Toleranzen, um Festigkeit, Haltbarkeit und Rundlauf zu gewährleisten. Alle Ritzel haben eine ultrapräzise Zahnform für einen vibrationsfreien Betrieb. Jedes Kettenrad ist zur schnellen und einfachen Identifizierung mit der Anzahl der Zähne gekennzeichnet. Passend für alle Fahrzeuge mit MOD1-Getriebe (Maßstab 1/8)



High-performance tandwiel, geproduceerd van speciaal staal met nauwkeurige toleranties om sterkte, duurzaamheid en concentriciteit te garanderen. Alle kettingwielen hebben een ultra-precieze tandvorm voor een trillingsvrije werking. Elk tandwiel is gemarkeerd met het aantal tanden voor een snelle en eenvoudige identificatie. Past op alle auto's met MOD1 versnellingen (1/8 Schaal)

SPEED GEAR CHART - TABLEAU DES VITESSES - DREHZAHLGANGDIAGRAMM - VERSNELLINGSTABEL

GEAR RATIO : 3.31	Km/h	Mph	Km/h	Mph	Km/h	Mph	Km/h	Mph	Km/h	Mph	Km/h	Mph
Gear	11T Pinion		12T Pinion		13T Pinion		14T Pinion		15T Pinion		16T Pinion	
52T	15,64		14,33		13,23		12,29		11,47		10,75	
4S	59	37	64	40	70	43	75	47	80	50	86	53
6S	89	55	97	60	105	65	113	70	121	75	129	80

- OK
- Factory fitted
- Usable but not recommended
- Not recommended, at your own risk



Note: The speed indicated in the table is a theoretical speed for information purposes. The real speed varies according to the type of terrain, electronic equipment, atmospheric conditions, type of tyre and its diameter and other driving parameters.

Note: La vitesse indiquée dans le tableau est une vitesse théorique à titre indicatif. La vitesse réelle varie en fonction du type de terrain, de l'équipement électronique, des conditions atmosphériques, du type de pneu et son diamètre et d'autres paramètres de conduite.

Bemerkung: Die in der Tabelle angegebene Geschwindigkeit ist eine theoretische Geschwindigkeit, die nur als Referenz dient. Die tatsächliche Geschwindigkeit hängt von der Art des Geländes, der elektronischen Ausrüstung, den Wetterbedingungen, des Reifentyps und seines Durchmessers und anderen Fahrparametern ab.

Nota: De in de tabel aangegeven snelheid is een theoretische snelheid, uitsluitend ter referentie. De werkelijke snelheid varieert afhankelijk van het soort terrein, de elektronische apparatuur, de weersomstandigheden, het type band en zijn diameter en andere rijparameters.

OPTION M1.0 Pinion - Hardened Steel - for Shaft Dia. 5mm

- C-72711** - Pinion 11 Teeth
- C-72712** - Pinion 12 Teeth
- C-72713** - Pinion 13 Teeth
- C-72714** - Pinion 14 Teeth
- C-72715** - Pinion 15 Teeth
- C-72716** - Pinion 16 Teeth



GEAR MESH ADJUSTMENT - AJUSTEMENT DE L'ENGRENAGE - GETRIEBEVERSTELLUNG - TANDWIELAFSTELLING



If the gear mesh is not correct, you wear out the spur gear prematurely, the transmission will make noise, give unnecessary load on the motor (higher consumption, heating of the transmission).



Si l'espace entre le pignon et la couronne n'est pas correct, la couronne dentée s'use prématurément, la transmission fait du bruit et le moteur est inutilement sollicité (consommation plus élevée, échauffement de la transmission).



Wenn der Abstand zwischen Ritzel und Tellerrad nicht stimmt, verschleißt das Zahnrad vorzeitig, das Getriebe macht Geräusche und der Motor wird unnötig belastet (höherer Verbrauch, Erwärmung des Getriebes).



Als de afstand tussen het tandwiel en de recht tandwiel niet correct is, slijt de recht tandwiel voortijdig, maakt de transmissie lawaai en wordt de motor onnodig belast (hogere verbruik, verhitting van de transmissie).

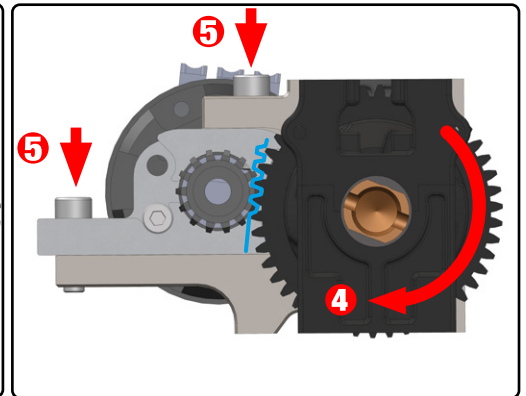
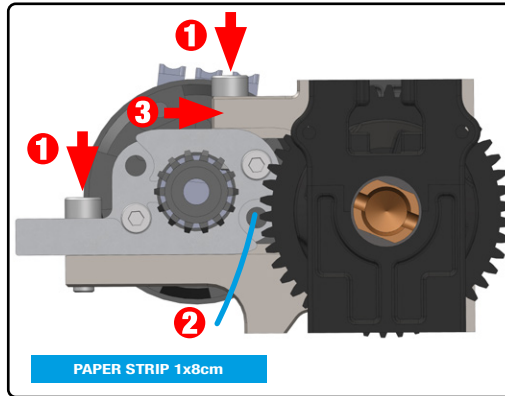
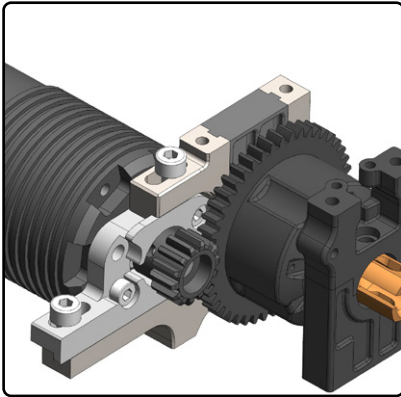

1. Loosen the screws.

Desserrez les vis.
Lösen Sie die Schrauben.
Draai de schroeven los.

2. Insert the paper strip.

Insérez la bande de papier.
Legen Sie den Papierstreifen ein.
Plaats de papierstrook.

3. Push the motor against the spur gear.

Poussez le moteur contre la couronne dentée.
Schieben Sie den Motor gegen das Zahnrad.
Duw de motor tegen het recht tandwiel.

4. Turn the spur gear to run the paper through the teeth.

Stop when the paper is in the middle.
Make sure that the motor pinion is against the spur gear.

Tournez la couronne dentée pour faire passer le papier entre les dents.
Arrêtez lorsque le papier est au milieu.
Assurez-vous que le pignon du moteur est contre la couronne dentée.

Drehen Sie das Hauptzahnrad, um das Papier durch die Zähne zu führen.
Halten Sie an, wenn sich das Papier in der Mitte befindet.
Achten Sie darauf, dass das Motorritzel am Hauptzahnrad anliegt.

Draai aan het rechte tandwiel om het papier door de tanden te laten lopen.
Stop wanneer het papier in het midden is.
Zorg ervoor dat het motortandwiel tegen het rechte tandwiel staat.

5. Maintain and tighten the fixing screws.

Maintenez et serrez les vis de fixation.
Halten Sie die Befestigungsschrauben fest und ziehen Sie sie an.
De bevestigingsschroeven aanhouden en vastdraaien.



It may be necessary to replace the silicone oil in the shock absorbers every 40 runs (depends on how you drive and the type of terrain you drive on).
 Il peut être nécessaire de remplacer l'huile silicone des amortisseurs toutes les 40 courses (cela dépend de votre conduite et du type de terrain sur lequel vous roulez).
 Es kann notwendig sein, das Silikonöl in den Stoßdämpfern alle 40 Fahrten zu wechseln (abhängig von Ihrer Fahrweise und dem Gelände, auf dem Sie fahren).
 Het kan nodig zijn de siliconenolie in de schokdempers om de 40 ritten te vervangen (afhankelijk van uw rijstijl en het soort terrein waarop u rijdt).

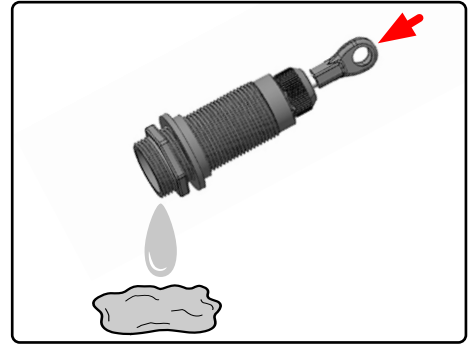
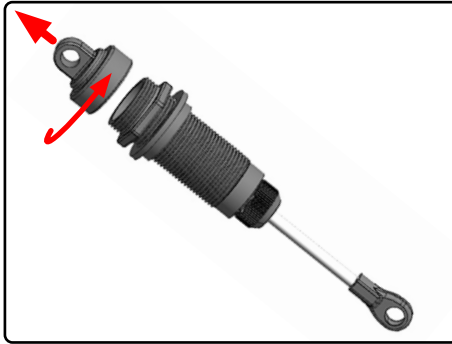
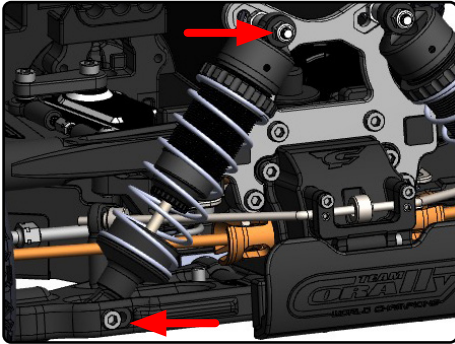

ALWAYS USE SILICONE OIL, NEVER USE ANY OTHER TYPES OF OIL.

FILL	MOVE UP	WAIT	TIGHTEN 50%	MOVE UP	TIGHTEN FULLY
<p>• Fill the shock with silicone oil.</p> <p>• Remplissez l'amortisseur avec de l'huile de silicone.</p> <p>• Füllen Sie den Dämpfer mit Silikonöl.</p> <p>• Vul de schokdemper met siliconenolie.</p>	<p>• Move the piston up&down (3-4x) to release the air bubbles in the silicone oil.</p> <p>• Déplacez le piston de haut en bas (3-4x) pour libérer les bulles d'air.</p> <p>• Bewegen Sie den Kolben nach oben&unten (3-4x), um die Luftblasen abzulassen.</p> <p>• Beweeg de zuiger op en neer (3-4x) om de luchtbel-len te laten ontsnappen.</p>	<p>• Pull the Shock shaft down and wait until the bubbles rise to the surface.</p> <p>• Tirez la tige d'amortisseur vers le bas et attendez que les bulles remontent à la surface.</p> <p>• Ziehen Sie die Schockwelle nach unten und warten Sie, bis die Blasen an die Oberfläche steigen.</p> <p>• Trek de Schokas naar beneden en wacht tot de luchtballen naar de oppervlakte stijgen.</p>	<p>• Screw in the shock absorber cap at 50%.</p> <p>• Vissez le bouchon d'amortisseur à 50%</p> <p>• Schrauben Sie die Stoßdämpferkappe zu 50 % ein.</p> <p>• Schroef de dop van de schokdemper op 50%.</p>	<p>• Gently move the piston in upper position, the oil excess will flow out.</p> <p>• Déplacez doucement le piston en position haute, l'excédent d'huile s'écoulera.</p> <p>• Bewegen Sie den Kolben vorsichtig in die obere Position, das überschüssige Öl fließt dann heraus.</p> <p>• Beweeg de piston langzaam in de bovenste positie, de overtollige olie zal eruit stromen.</p>	<p>• Now tighten the cap fully but not too much otherwise the membrane will be deformed.</p> <p>• Maintenant, serrez le bouchon à fond, mais pas trop, sinon la membrane sera déformée.</p> <p>• Ziehen Sie nun die Kappe vollständig, aber nicht zu fest an, da sonst die Membran verformt wird.</p> <p>• Draai nu de dop helemaal vast, maar niet te vast, anders wordt het membraan vervormd.</p>

	FRONT		REAR		SHOCK PISTON
	SILICONE OIL	SPRING TENSION	SILICONE OIL	SPRING TENSION	
TRACK USE	450CPS	4mm	400CPS	0mm	6 Holes Ø1.3mm
OFF-ROAD	600CPS	4mm	500CPS	0mm	6 Holes Ø1.3mm
FACTORY	1000CPS		1000CPS		6 Holes Ø1.3mm



- **Do not overtighten the Shock Cap to prevent deformation of the silicone Shock Bladder.**
- *Ne serrez pas trop le capuchon de l'amortisseur pour éviter la déformation de la membrane en silicone.*
- Ziehen Sie die Dämpferabdeckung nicht zu fest an, um eine Verformung der Silikonmembran zu vermeiden.
- *Draai de schokkap niet te strak aan om vervorming van het siliconenmembraan te voorkomen.*

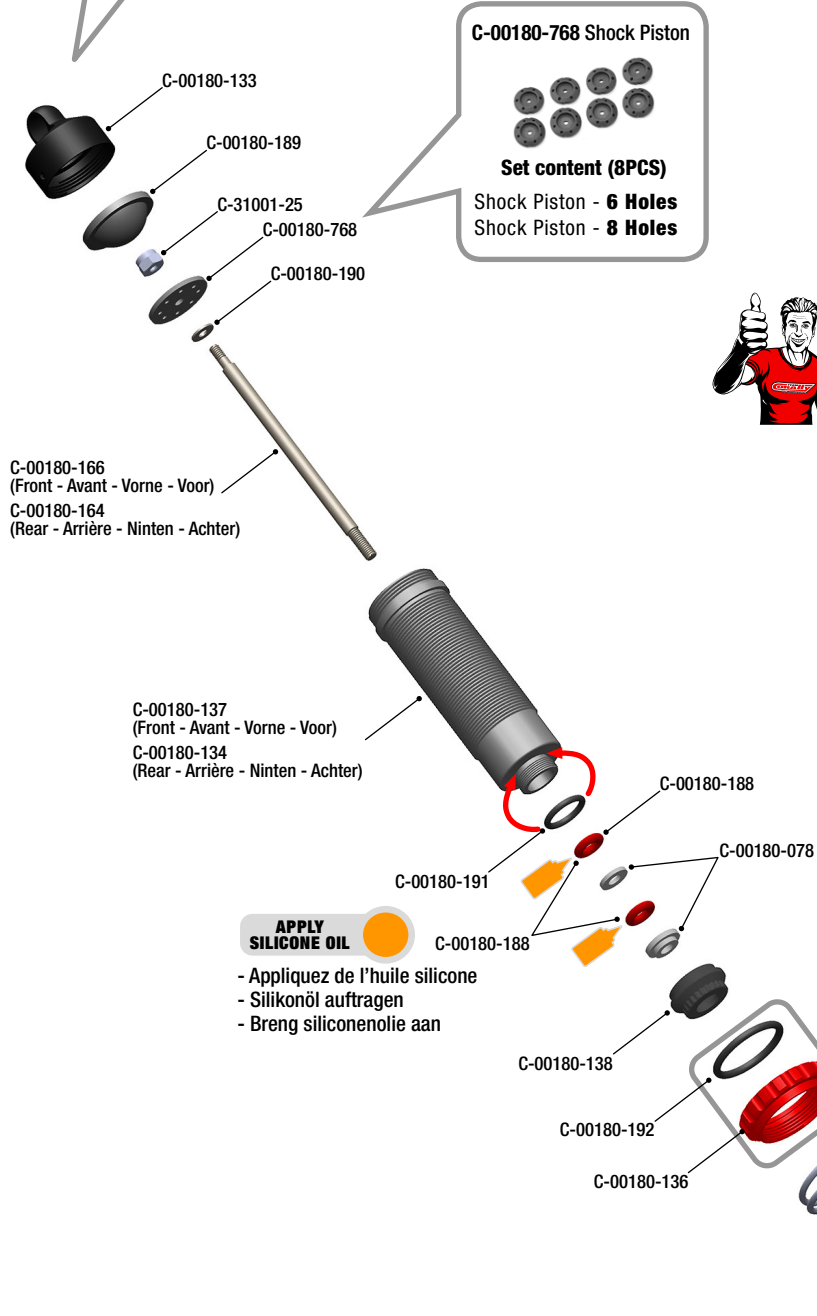

C-00180-768 Shock Piston

Set content (8PCS)
 Shock Piston - **6 Holes**
 Shock Piston - **8 Holes**

C-00180-768 Shock Piston (8pcs)
 Shock Piston - **6 Holes 1.4**
 Shock Piston - **8 Holes 1.2** (Factory installed)



- Place all small parts on a screwdriver (Ø3mm) and push them into the shock body. All parts will be properly aligned.

- *Placez toutes les petites pièces sur un tournevis (Ø3mm) et poussez-les dans le corps de l'amortisseur. Toutes les pièces seront correctement alignées.*

- Setzen Sie alle Kleinteile auf einen Schraubendreher (Ø3mm) und drücken Sie sie in den Dämpferkörper. Alle Teile werden richtig ausgerichtet.

- *Plaats alle kleine onderdelen op een schroevendraaier (Ø3mm) en duw ze in de behuizing van de schokdemper. Alle onderdelen zullen goed uitgelijnd zijn.*

APPLY SILICONE OIL

- Appliquez de l'huile silicone
- Silikonöl auftragen
- Breng siliconenolie aan

OPTION

REF	TYPE	POSITION	THICKNESS	LENGTH	
C-00180-289	Shock Spring	SOFT	FRONT	1.4mm	L: 84-86mm
C-00180-290	Shock Spring	MEDIUM	FRONT	1.6mm	L: 84-86mm
C-00180-291	Shock Spring	HARD	FRONT	1.8mm	L: 84-86mm
C-00180-286	Shock Spring	SOFT	REAR	1.4mm	L: 95-97mm
C-00180-287	Shock Spring	MEDIUM	REAR	1.6mm	L: 95-97mm
C-00180-288	Shock Spring	HARD	REAR	1.8mm	L: 95-97mm

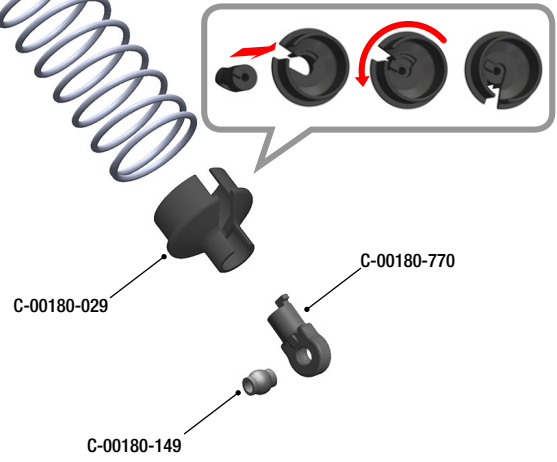



It may be necessary to replace the silicone oil every 50 runs (depends on how you drive and the type of terrain you drive on).
To remove the FR&RE differentials, follow the steps below.



Il peut être nécessaire de remplacer l'huile silicone toutes les 50 courses (cela dépend de votre conduite et du type de terrain sur lequel vous roulez).
Pour extraire les différentiels AV et AR, suivez les étapes indiquées ci-dessous.



Es kann notwendig sein, das Silikonöl alle 50 Fahrten zu wechseln (abhängig von Ihrer Fahrweise und dem Gelände, auf dem Sie fahren).
Um das Vorder- und Hinterachsdifferential herauszuziehen, befolgen Sie die unten beschriebenen Schritte.



Het kan nodig zijn de siliconenolie om de 50 ritten te vervangen (afhankelijk van uw rijstijl en het soort terrein waarop u rijdt).
Volg de onderstaande stappen om het voor- en achterdifferentieel te verwijderen.

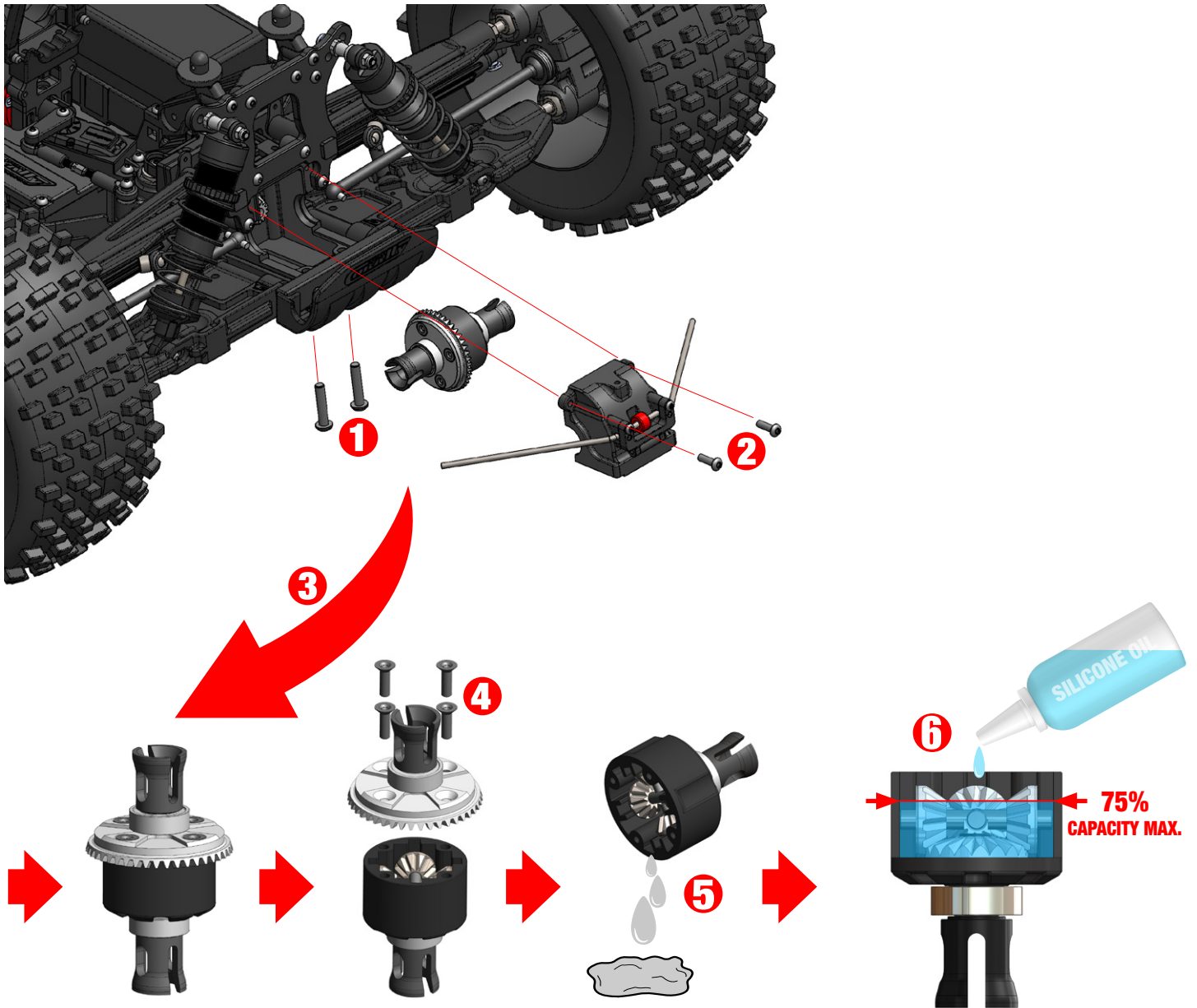

Perform the same maintenance operation for the Centre and Rear differentials.

Effectuez la même opération d'entretien pour les différentiels central et arrière.

Führen Sie die gleichen Wartungsarbeiten für das mittlere und hintere Differential durch.

Doe dezelfde onderhoudswerkzaamheden voor het midden- en achterdifferentieel.

www.corally.com/Chemicals/Silicone-Oils/



	FRONT DIFF	CENTRE DIFF	REAR DIFF
TRACK USE	7500CPS	15.000CPS	5000CPS
OFF-ROAD	10.000CPS	30.000CPS	7500CPS
BASHING	20.000CPS	100.000CPS	10.000CPS
FACTORY	20.000CPS	100.000CPS	10.000CPS



It may be necessary to replace the silicone oil every 50 runs (depends on how you drive and the type of terrain you drive on).
To remove the centre differential, follow the steps below.



Il peut être nécessaire de remplacer l'huile silicone toutes les 50 courses (cela dépend de votre conduite et du type de terrain sur lequel vous roulez).
Pour extraire le différentiel central, suivez les étapes indiquées ci-dessous.



Es kann notwendig sein, das Silikonöl alle 50 Fahrten zu wechseln (abhängig von Ihrer Fahrweise und dem Gelände, auf dem Sie fahren).
Um das Mitteldifferenzial herauszuziehen, befolgen Sie die unten angegebenen Schritte.



Het kan nodig zijn de siliconenolie om de 50 ritten te vervangen (afhankelijk van uw rijstijl en het soort terrein waarop u rijdt).
Volg onderstaande stappen om het middendifferentieel te verwijderen.

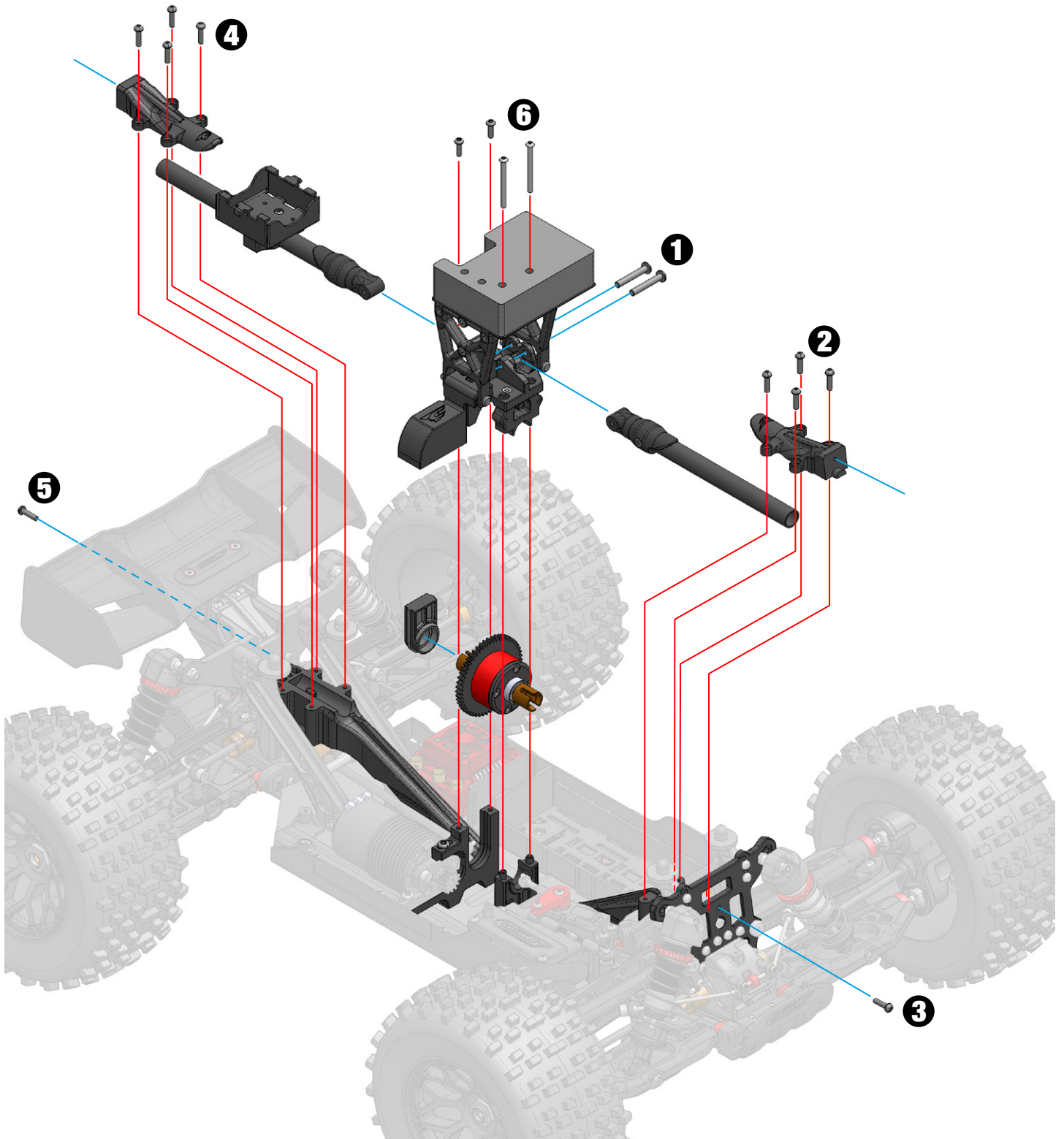

FRONT & REAR DIFFERENTIAL - DIFFÉRENTIEL AVANT ET ARRIÈRE - DIFFERENTIAL VORNE UND HINTEN - VOOR & ACHTER DIFFERENTIEEL

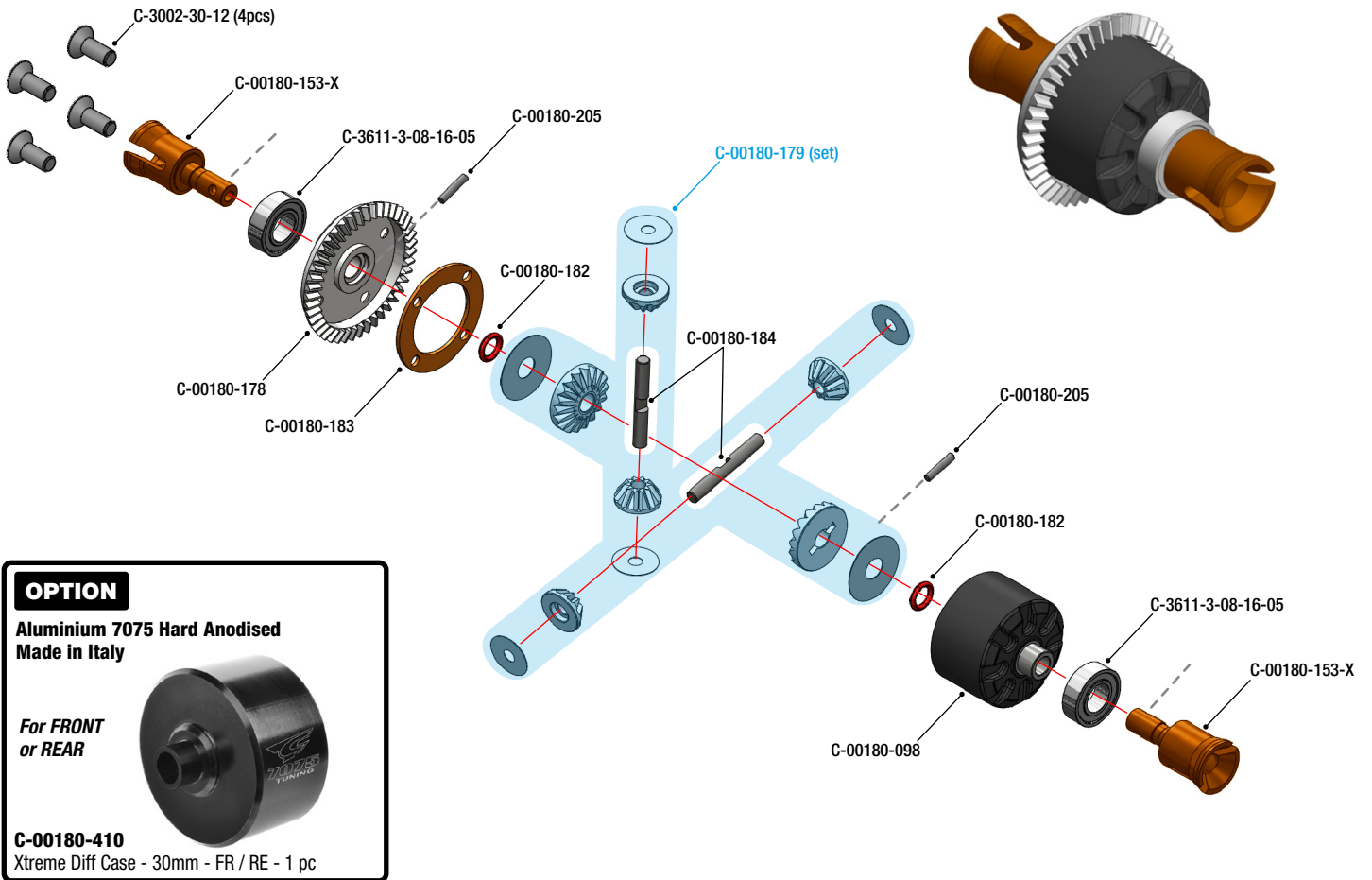

CENTRE DIFFERENTIAL - DIFFÉRENTIEL CENTRAL - ZENTRALDIFFERENTIAL - CentreDIFFERENTIEEL

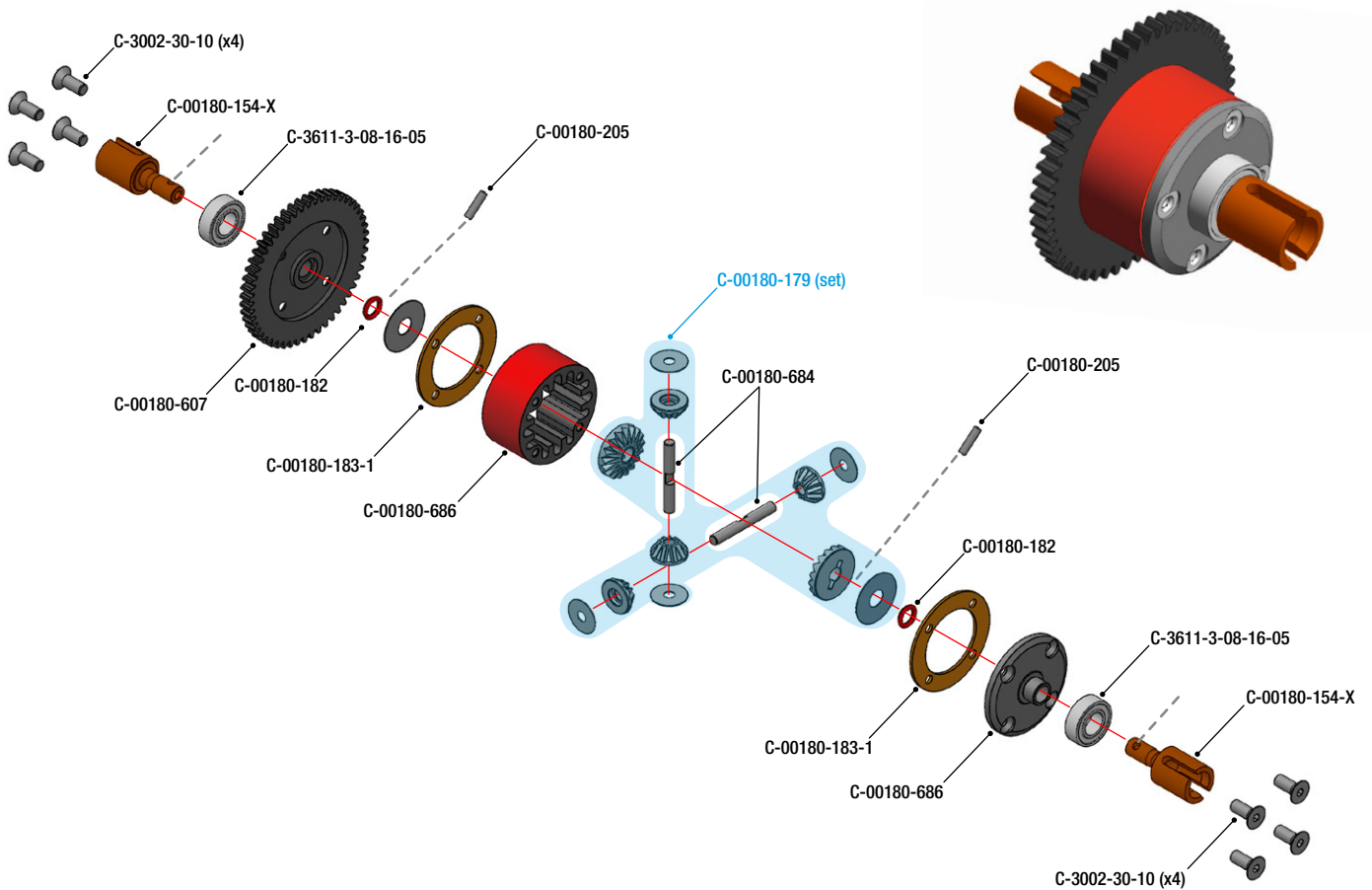

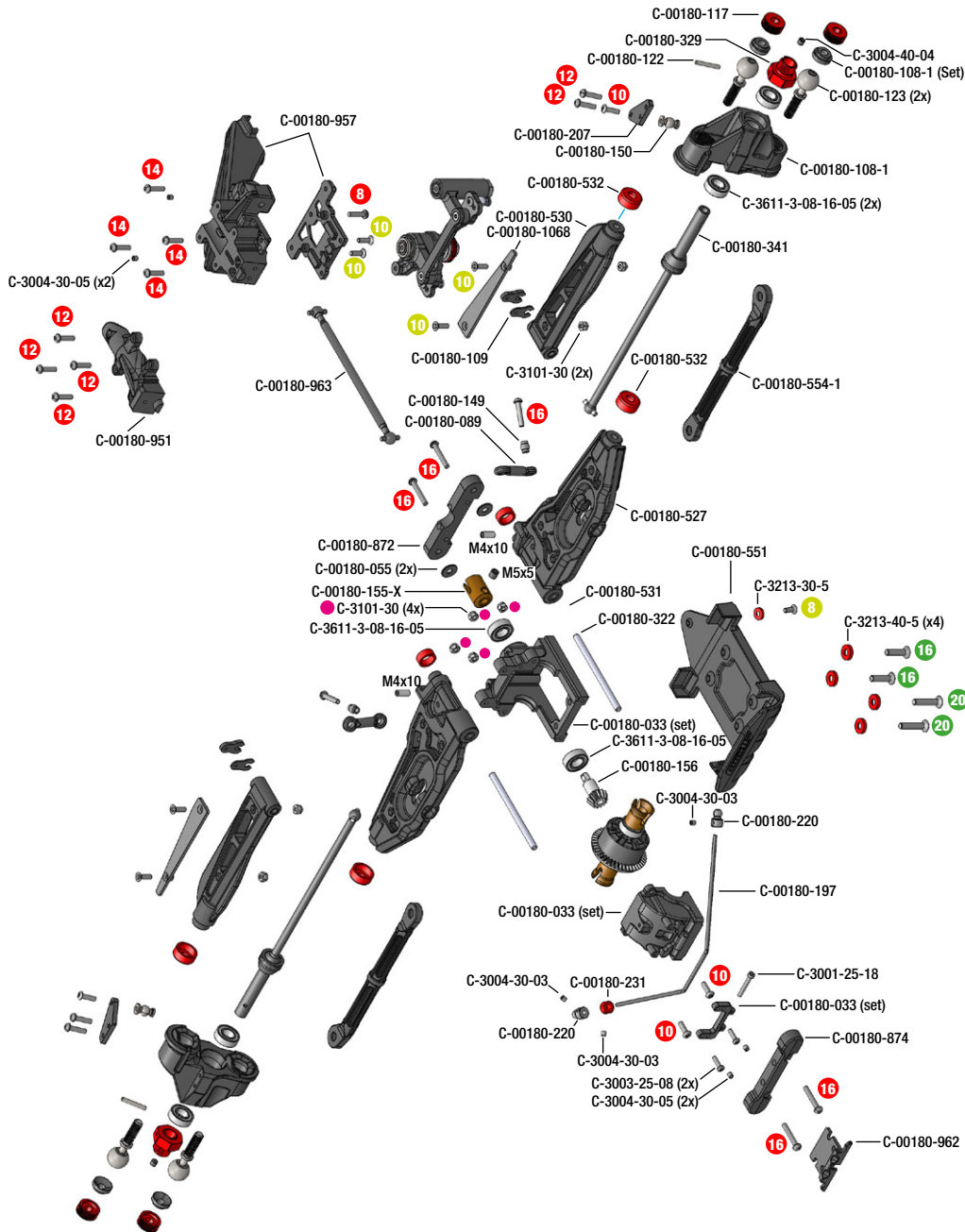

HEX BUTTON HEAD SCREWS DIN 7380 - STEEL - 10 PCS	
8	M3x8mm #C-3003-30-08
10	M3x10mm #C-3003-30-10
12	M3x12mm #C-3003-30-12
14	M3x14mm #C-3003-30-14
16	M3x16mm #C-3003-30-16
20	M3x20mm #C-3003-30-20
22	M3x22mm #C-3003-30-22

HEX FLAT HEAD SCREWS DIN 7991 - STEEL - 10 PCS	
8	M3x8mm #C-3002-30-08
10	M3x10mm #C-3002-30-10
12	M3x12mm #C-3002-30-12
16	M4x16mm #C-3002-40-16
20	M4x20mm #C-3002-40-20

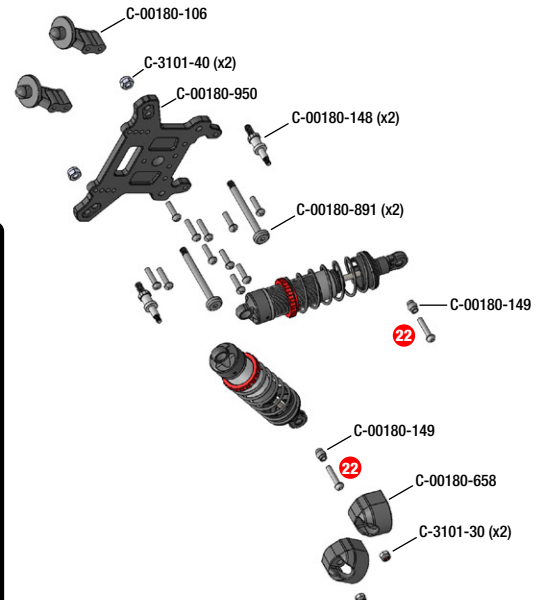

OPTION

**Aluminium 7075
Hard Anodised**

*Fit FRONT
or REAR*

C-00180-854
Gearbox Case Set - Swiss Made 7075 T6 - Black - Set

Front Shock-tower - Screws description

Diagram of the front shock-tower with callouts for screw locations: 10, 12, 14.

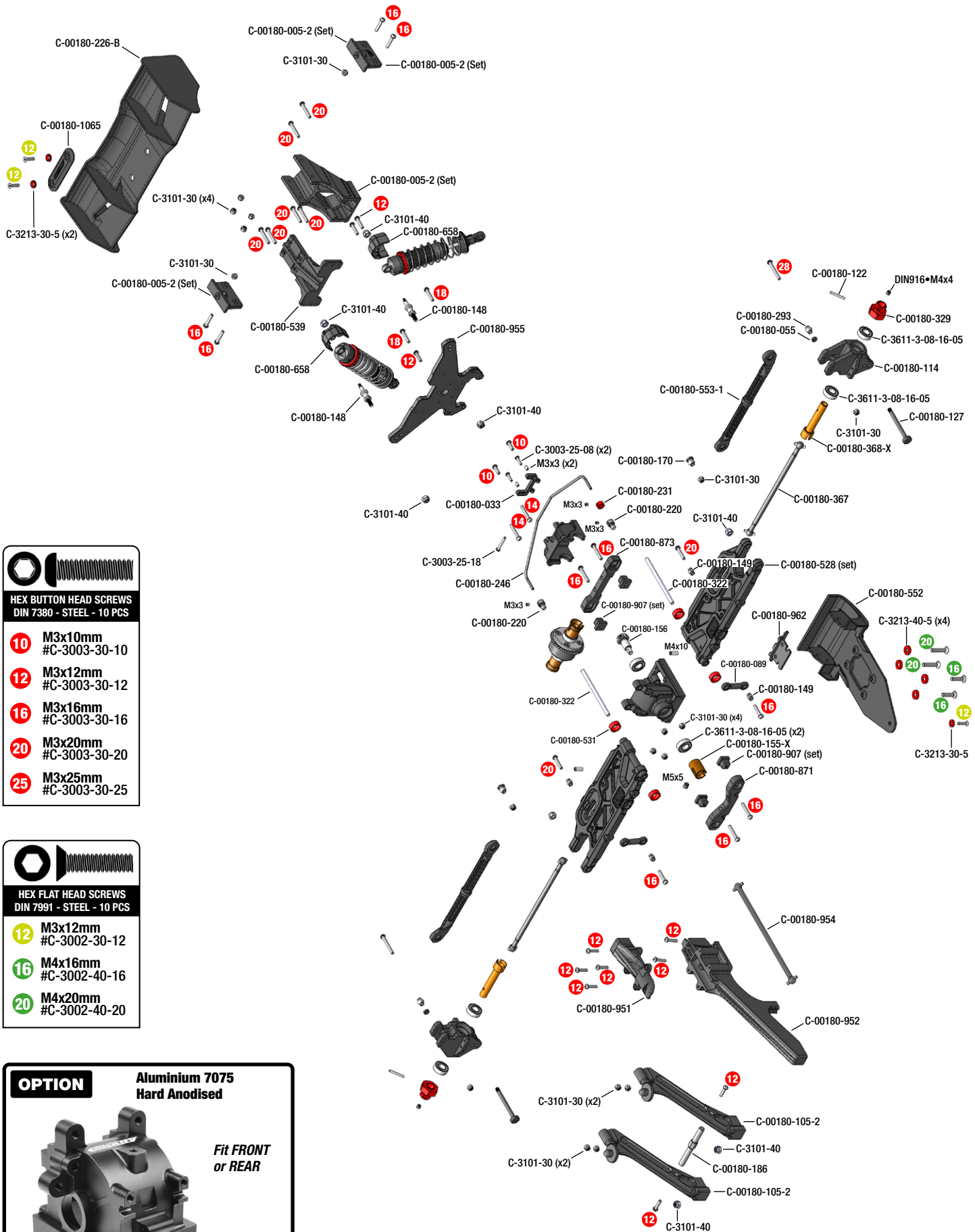

**HEX BUTTON HEAD SCREWS
DIN 7380 - STEEL - 10 PCS**

- 10** M3x10mm
#C-3003-30-10
- 12** M3x12mm
#C-3003-30-12
- 16** M3x16mm
#C-3003-30-16
- 20** M3x20mm
#C-3003-30-20
- 25** M3x25mm
#C-3003-30-25

**HEX FLAT HEAD SCREWS
DIN 7991 - STEEL - 10 PCS**

- 12** M3x12mm
#C-3002-30-12
- 16** M4x16mm
#C-3002-40-16
- 20** M4x20mm
#C-3002-40-20

OPTION **Aluminium 7075
Hard Anodised**

*Fit FRONT
or REAR*

C-00180-854
Gearbox Case Set - Swiss Made 7075 T6 - Black - Set

CHASSIS CENTRE

Electronics not included

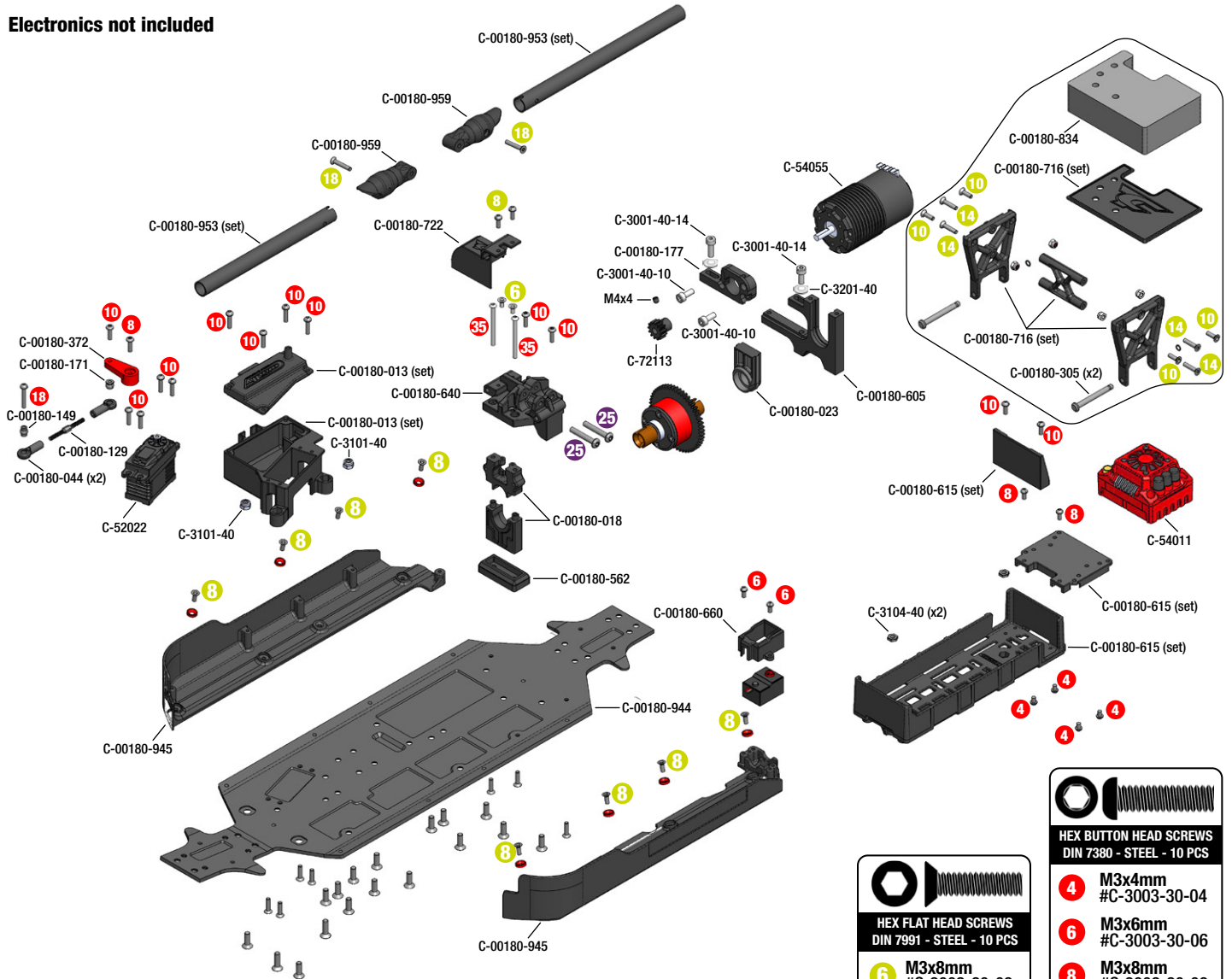

**HEX FLAT HEAD SCREWS
DIN 7991 - STEEL - 10 PCS**

6	M3x8mm #C-3002-30-08
8	M3x8mm #C-3002-30-08
10	M3x10mm #C-3002-30-10
12	M3x12mm #C-3002-30-12
14	M3x14mm #C-3002-30-14
18	M3x18mm #C-3002-30-18
16	M4x16mm #C-3002-40-16
20	M4x20mm #C-3002-40-20

**HEX BUTTON HEAD SCREWS
DIN 7380 - STEEL - 10 PCS**

4	M3x4mm #C-3003-30-04
6	M3x6mm #C-3003-30-06
8	M3x8mm #C-3003-30-08
10	M3x10mm #C-3003-30-10
12	M3x12mm #C-3003-30-12
16	M3x16mm #C-3003-30-16
20	M3x20mm #C-3003-30-20
25	M3x25mm #C-3003-30-25
35	M3x35mm #C-3003-30-35
25	M4x25mm #C-3003-40-25

CHASSIS - SCREWS DESCRIPTION - VISSERIE CHÂSSIS - SCHRAUBEN - SCHROEVEN

- M3x8mm DIN7991
#C-3002-30-08
- M3x12mm DIN7991
#C-3002-30-12
- M4x10mm DIN7991
#C-3002-40-10
- M4x12mm DIN7991
#C-3002-40-12
- M4x14mm DIN7991
#C-3002-40-14
- M4x16mm DIN7991
#C-3002-40-16
- M4x20mm DIN7991
#C-3002-40-20

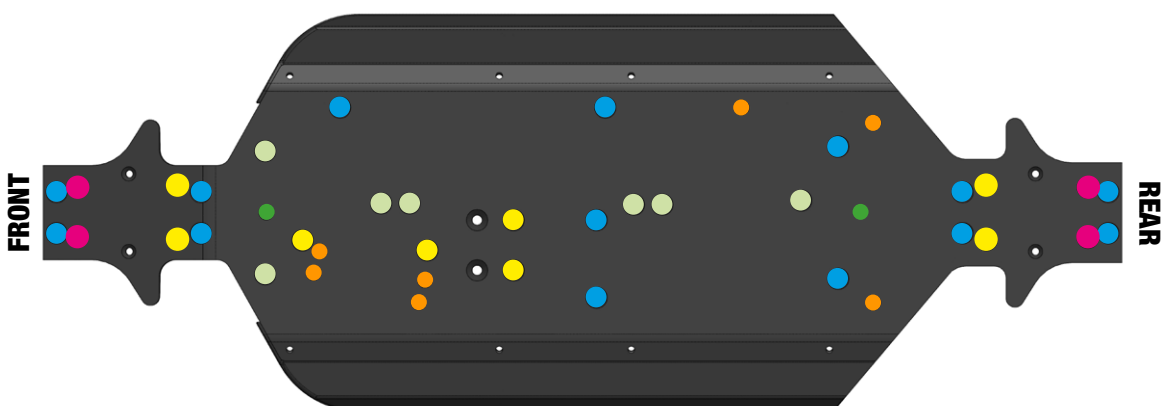

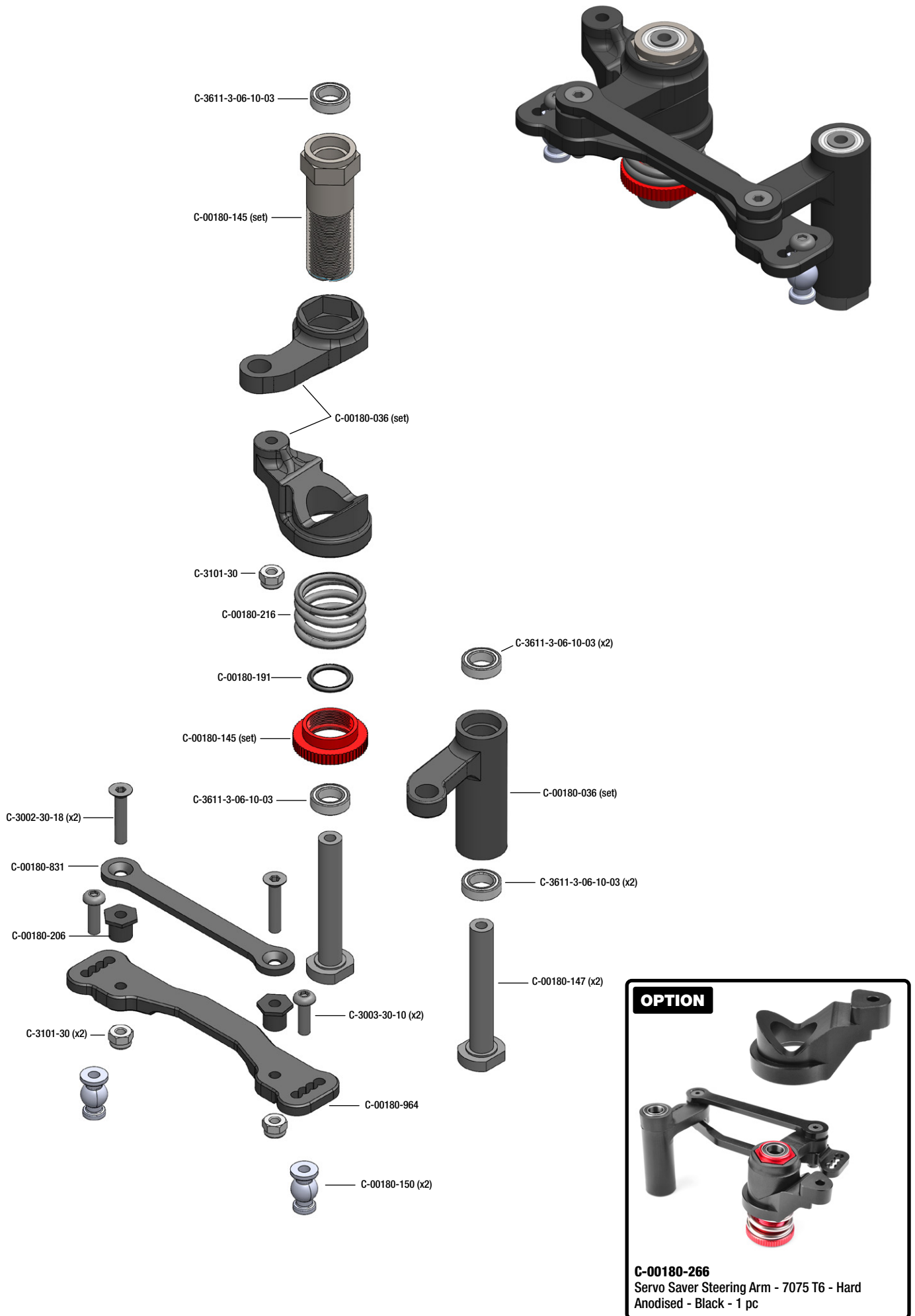



C-00180-004-1
Battery Strap - Hook & Loop
- 2 pcs



C-00180-005-2
Wing Mount - Adjustable - Composite - 1 Set



C-00180-013
Servo Mount - Receiver Box - Composite - 1 Set



C-00180-018
Centre Diff Bulkhead - Composite - 1 Set



C-00180-023
Motor Mount Centre Diff Insert - Composite - 1 pc

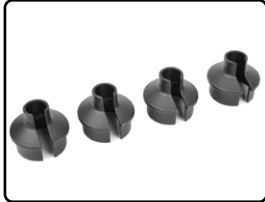

C-00180-029
Shock Spring Cup - Composite - 4 pcs



C-00180-033
Bumper - Front - Rear - Composite - 1 set



C-00180-036
Steering Bellcrank - Parts A-B-C - Composite - 1 Set



C-00180-044
Ball Joint 6mm - Composite - 2 pcs

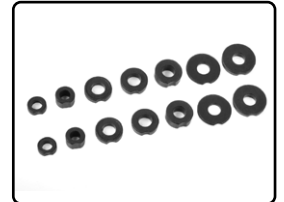

C-00180-055
Suspension Arm Shim - Composite - 1 Set



C-00180-089
Anti-Roll Bar Ball Cups - Composite - 4 pcs



C-00180-098
Diff Case - FR-RE - Composite - 1 pc



C-00180-105-2
Shock Tower Brace - Body Mount - Rear - Composite - 2 pcs



C-00180-106
Body Post - Front - Composite - 2 pcs



C-00180-108-1
HD Steering Block Wide - Pivot Ball Cup (2) - Composite - 1 set

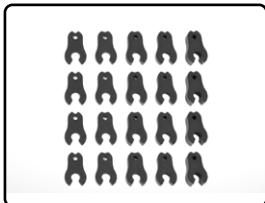

C-00180-109
Caster Clips Set - 1 to 4.5mm - 1 Set



C-00180-114
Composite Rear Upright - Wide - 1 pc



C-00180-117
Pivot Ball Adjusting Nut - Aluminium - 4 pcs

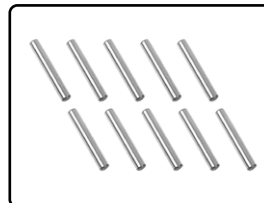

C-00180-122
Pin 2.5x17mm - Steel - 10 pcs



C-00180-123
Pivot Ball - Steel - 4 pcs



C-00180-127
Hinge Pin - Outer - Steel - 2 pcs



C-00180-129
Turnbuckle - M3 - 35mm - Steel - 2 pcs



C-00180-145
Servo Saver Shaft w/ Nut - Aluminium - 1 pc



C-00180-147
Servo Saver Post - Steel - 2 pcs



C-00180-148
Shock Screw - Steel - 4 pcs



C-00180-149
Ball - 5.8mm - Steel - 4 pcs



C-00180-150
Ball Shouldered - 6.8mm - Steel - 4 pcs



C-00180-170
Ball - 6.8mm - Steel - 2 pcs



C-00180-171
Threaded Ball - 6mm - Steel - 2 pcs



C-00180-177
Motor Mount - Aluminium - 1 pc



C-00180-186
Chassis Brace Link - Steel - 1 pc



C-00180-197
Anti-Roll Bar - 2.4mm - Front - 1 pc



C-00180-206
Steering Rack Bushing - Steel - 2 pcs



C-00180-207
Steering Block Arms - Aluminium - 2 pcs



C-00180-216
Servo Saver Spring - 1 pc



C-00180-220
Ball End 5.8mm - for Anti Roll Bar - Steel - 4 pcs



C-00180-226-B
Wing - Composite - 1 pc

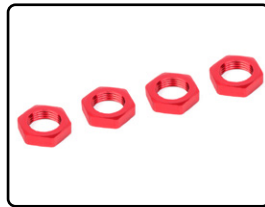

C-00180-230
Wheel Nut - Aluminium - Ribbed - 4 pcs



C-00180-231
Collar - for Anti-roll Bar - Aluminium - 1 pc

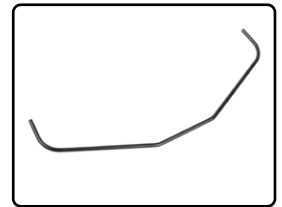

C-00180-246
Anti-Roll Bar - Rear - 2.6mm - 1 pc

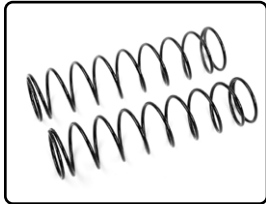

C-00180-288
Shock Spring - HARD - Rear - 2 pcs

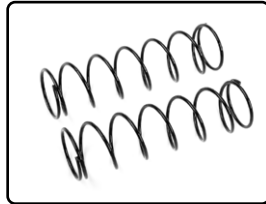

C-00180-291
Shock Spring - HARD - Front - 2 pcs



C-00180-293
Ball 6.8mm - Steel - 4 pcs

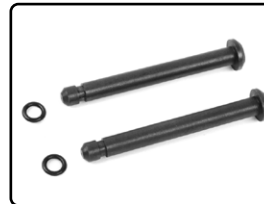

C-00180-305
Centre Roll Cage Pin - Steel - 2 pcs



C-00180-322
Suspension Arm Pivot Pin - Lower Inner - Fr/Re - Steel - 2 pcs



C-00180-329
Wheel Hex Adapter - Wide RTR - Aluminium - 2 pcs



C-00180-341
CVD Drive Shaft - Long - Front - Wide Blocks - 1 pc



C-00180-367
Universal Drive Shaft - Truggy - MTL - Rear - 2 pcs



C-00180-368-X
PRO Drive Axle - Long - Rear - Swiss Spring Steel - 2 pcs



C-00180-372
Servo Arm - Aluminium - 1 pc



C-00180-378-1
MT - Racing Tires Glued on BBS-Rims - 2 pcs



C-00180-527
Suspension Arm Long with Rings - Lower - Front - Composite - 1 pc



C-00180-528
Susp. Arm Long with Rings - Lower - Rear - Composite - 1 pc



C-00180-530
Susp. Arm Long with Ring - Upper - Front - Composite - 1 pc

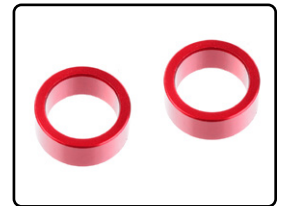

C-00180-531
HDA Suspension Arm Insert - Inner - Aluminium - Red - 2 pcs



C-00180-532
HDA Susp. Arm Insert - Outer - Spacer 1.5mm - Alum - Red - 2 pcs



C-00180-539
Wing Mount Connecting Brace - Composite - 1 Pc



C-00180-551
Front Bumper - Composite. - 1 pc



C-00180-552
Rear Bumper - Composite. - 1 pc

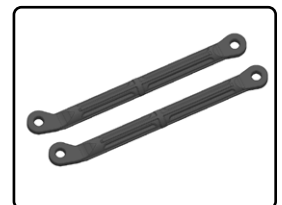

C-00180-553-1
HD Camber Links - HDA-3 - 135mm - Composite - 2 pcs



C-00180-554-1
HD Steering Links - HDA-3 - 118mm - Composite - 2 pcs



C-00180-562
Centre Diff Support Spacer - 4mm - Composite - 1 pc



C-00180-605
Motor Bulkhead - Aluminium - 1 pc

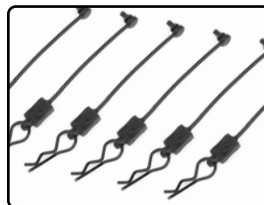

C-00180-614
Body Clip Retainer w/ Body clip - Black - 6 pcs



C-00180-615
Battery Tray - Large - Composite - 1 set



C-00180-640
Centre Diff Plate - for Chassis Tube - Composite - 1 pc



C-00180-658
Shock absorber cover - Composite - 4 pcs

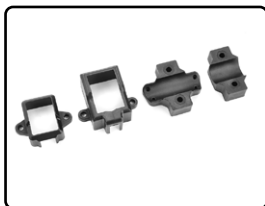

C-00180-660
Switch Holder TOROX 185-135 - Composite - 1 set

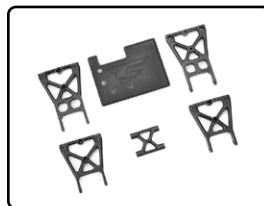

C-00180-716
Centre Roll Cage Mount - Composite - 1 Set



C-00180-722
Spur Gear Cover - Composite - 1 pc



C-00180-831
Steering Rack - Dual Stiffener - Aluminium - 1 Pc

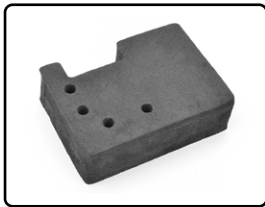

C-00180-834
Centre Roll Cage Foam - Thickness 25mm - 1 pc



C-00180-871
Suspension Arm Mount HD - RE-FR - 8mm - Aluminium - Black - 1 pc



C-00180-872
Suspension Arm Mount HD - FR-RE - 8mm - Aluminium - Black - 1 pc

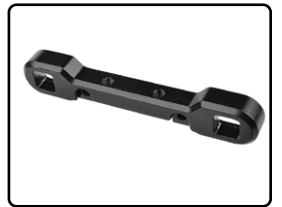

C-00180-873
Suspension Arm Mount HD - RE-RE - 8mm - Aluminium - Black - 1 pc



C-00180-874
Suspension Arm Mount HD - FR-FR - 8mm - Aluminium - Black - 1 pc



C-00180-891
Hinge Pin - Front Upper Arm - Steel - 2 pcs

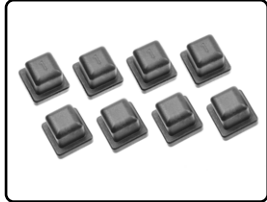

C-00180-907
Arm Holder Inserts - Composite - 0°, 1° - Set 8 pcs

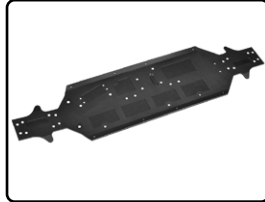

C-00180-944
Chassis - MT23 - Aluminium - 1 pc



C-00180-945
Side Guards - MT23 - Left-Right - Composite - 1 Set



C-00180-950
Shock Tower - MT23 - 5mm - Aluminium - Front - 1 pc

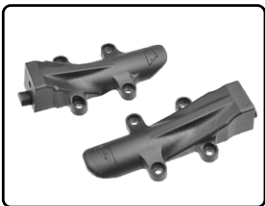

C-00180-951
Chassis Brace Tube Cover - Front - Rear - 1 Set

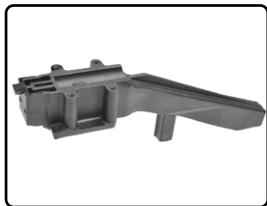

C-00180-952
Chassis Brace - MT23 - Rear - Composite - 1 pc

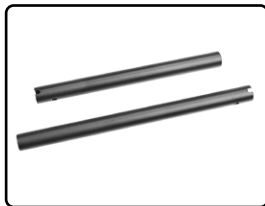

C-00180-953
Chassis Tube - MT23 - Front - Rear - Aluminium - Black - 1 Set

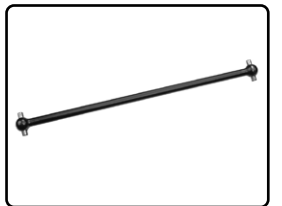

C-00180-954
Centre Drive Shaft - Rear - Steel - 141,5mm - 1 pc



C-00180-955
Shock Tower - MT23 - Rear - 5mm - Aluminium - Black - 1 pc

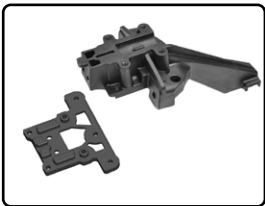

C-00180-957
Chassis Brace - MT23 - Front - Composite - 1 pc



C-00180-959
Chassis Tube Ends - MT23 - Composite - 2 pcs

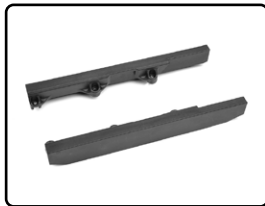

C-00180-960
Side Guard Adapters - MT23 - Left-Right - Composite - 1 Set

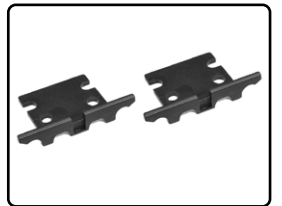

C-00180-962
Gear Box Cover - Composite - 1 Set

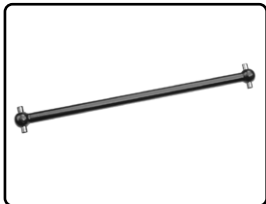

C-00180-963
Centre Drive Shaft - Front - Steel - 115,5mm - 1 pc



C-00180-964
Steering Rack - MT23 - 7075 - 3mm - Black - 1 pc



C-00180-981
Body - Clear - MT23 - KAGAMA - Cut - 1 pc



C-00180-982
Plastic Parts - Body MT23 - KAGAMA - 1 pc



C-00180-981-1
Painted Body - MT23 - KAGAMA RED - Cut - 1 pc



C-00180-981-2
Painted Body - MT23 - KAGAMA BLUE - Cut - 1 pc



C-00180-981-3
Painted Body - MT23 - KAGAMA GREEN - Cut - 1 pc

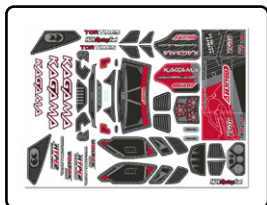

C-00180-981-4
Body Decal Sheet - KAGAMA - RED - 1 pc

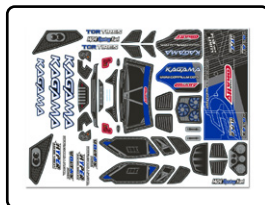

C-00180-981-5
Body Decal Sheet - KAGAMA - BLUE - 1 pc

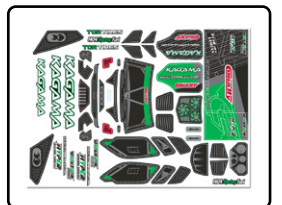

C-00180-981-6
Body Decal Sheet - KAGAMA - GREEN - 1 pc



C-00180-1020
Servo Steering Link - Composite - 1 pc



C-00180-1065
HD Wing Washer - Large - Composite - 1 pc



C-00180-1066
Mud Guards - Left - Right - Composite - 1 Pair



C-00180-1068
Front Upper Arm plate - Composite - 2 pcs

FRONT & REAR DIFFERENTIAL - SPARE PARTS

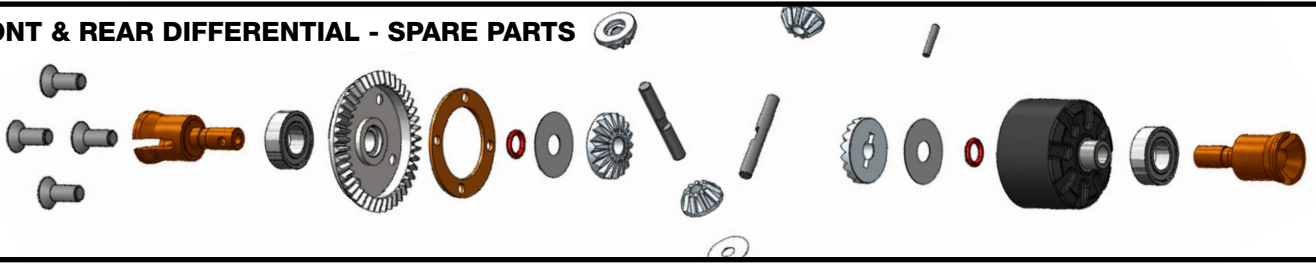

C-00180-090-1
Centre Diff set - Case + diff
internals - 1 set



C-00180-178
Diff. Bevel Gear 43T - Steel -
1 pc



C-00180-156
Bevel Pinion 13T - Steel - 1 pc

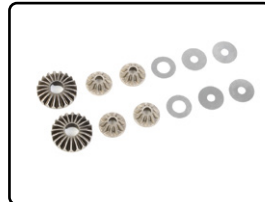

C-00180-179
Planetary Diff. Gears - Steel -
1 Set



C-00180-184
Gear Diff. Pin - Steel - 2 pcs



C-00180-205
Diff. Outdrive Pin - 2x11,8mm -
Steel - 4 pcs



C-00180-098
Diff Case - FR-RE - Composite
- 1 pc

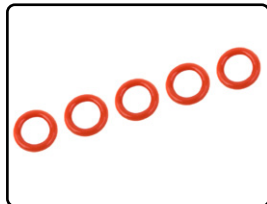

C-00180-182
O-Ring - Silicone - 5x8mm -
5 pcs

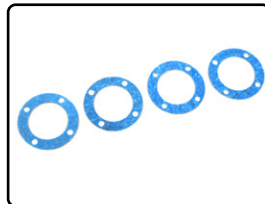

C-00180-183
Diff. Gasket - 4 pcs



C-00180-155-X
PRO Pinion Outdrive Cup -
Swiss Spring Steel - 2 pcs



C-00180-153-X
PRO Diff. Outdrive Cup - Swiss
Spring Steel - 2 pcs

CENTRE DIFFERENTIAL - SPARE PARTS



C-00180-154-X
PRO Centre Diff. Outdrive Cup -
Swiss Spring Steel - 2 pcs



For use with Diff Pin C-00180-684
C-00180-686
Diff Case - Centre - Aluminium.
- 1 pc



C-00180-607
Spur Gear 52T - Steel - 1 pc

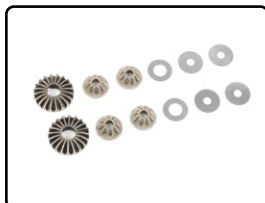

C-00180-179
Planetary Diff. Gears - Steel -
1 Set



For use with C-00180-686
C-00180-684
Gear Diff Pin - 3.5x29.8mm -
for C-00180-686 - Steel - 4 pcs



C-00180-183-1
Central Diff. Gasket - 4 pcs

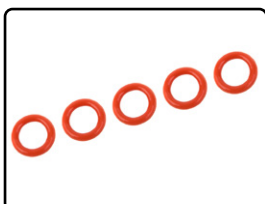

C-00180-182
O-Ring - Silicone - 5x8mm -
5 pcs

SHOCK ABSORBER - SPARE PARTS



C-00180-658
Shock Cap Cover - RTR - Composite - 2 pcs



C-00180-133
Shock Cap - Aluminium - Hard Anodised - 2 pcs

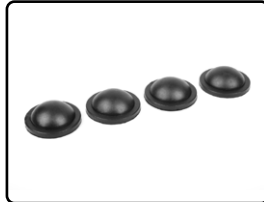

C-00180-189
Shock Bladders - Silicone - 4 pcs

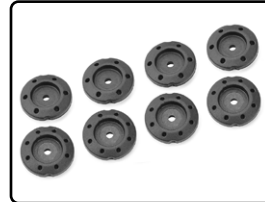

C-00180-768
Shock Piston Heavy Duty - 4mm thick - 8x1.2 + 6x1.4 - 1 Set

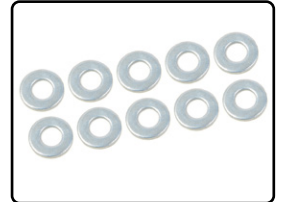

C-00180-190
Shock Washer - 2.5x6x0.5mm - Steel - 10 pcs



C-00180-164
Shock Shaft - 66mm - Rear - Steel - 2 pcs



C-00180-166
Shock Shaft - 61mm - Front - Steel - 2 pcs



C-00180-134
Shock Body - Rear - Aluminium - Hard Anodised - 1 pc



C-00180-137
Shock Body - Front - Aluminium - Hard Anodised - 1 pc

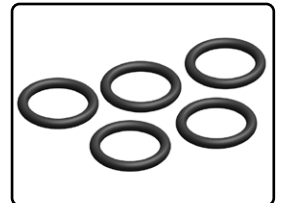

C-00180-191
O-Ring - Silicone - 9x12mm - 5 pcs

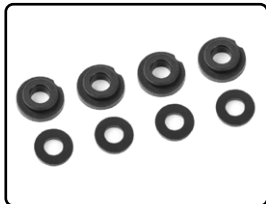

C-00180-078
Shock Body Insert - Washer - Composite - 1 set



C-00180-188
O-Ring - Silicone - 4x8mm - 5 pcs



C-00180-138
Shock Cap - Lower - Composite - 2 pcs

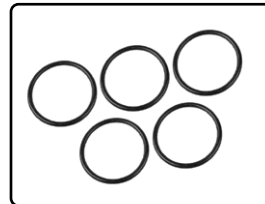

C-00180-192
O-Ring - Silicone - 16.2x19.8mm - 5 pcs



C-00180-136
Shock Collar - Aluminium - Hard Anodised - 2 pcs

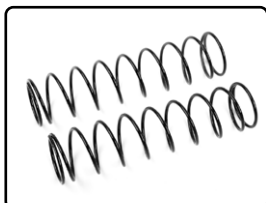

C-00180-288
Shock Spring - Hard - Rear - 2 pcs

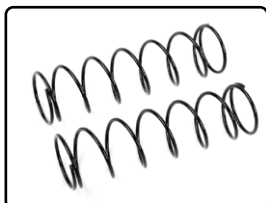

C-00180-291
Shock Spring - Hard - Front - 2 pcs

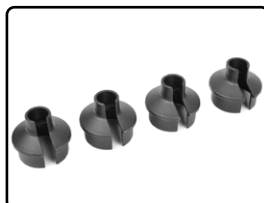

C-00180-029
Shock Spring Cup - Composite - 4 pcs



C-00180-770
HD Shock End - Short - Composite - 4 pcs



Check the availability of spare parts on the website www.corally.com

Visualisez la disponibilité des pièces de rechange sur le site web www.corally.com

Sehen Sie sich die Verfügbarkeit von Ersatzteilen auf der Website www.corally.com an.

Controleer de beschikbaarheid van reserveonderdelen op de website www.corally.com



C-00180-039
Steering Ball Cups - Composite
- 1 set



C-00180-041
Rear Camber Ball Cups - Outer
- Inner - 1 set



C-00180-143-2
Turnbuckle - M5 - 92mm -
Spring Steel - 2 pcs



C-00180-144-2
Turnbuckle - M4 - 92mm -
Spring Steel - 2 pcs



C-00180-316
Shock Cap - Lower - Aluminium
- 2 pcs

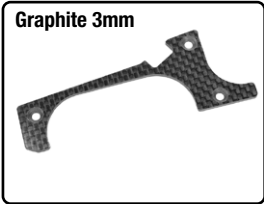

C-00180-838
Suspension arm stiffener -
Lower Front - Right - 1 pc



C-00180-839
Suspension arm stiffener -
Lower Front - Left - 1 pc

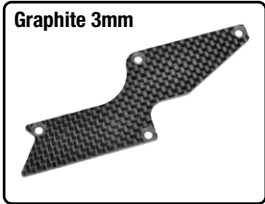

C-00180-840
Suspension arm stiffener -
Lower Rear - Right - 1 pc



C-00180-841
Suspension arm stiffener -
Lower Rear - Left - 1 pc

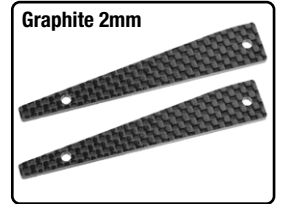

C-00180-842
Suspension arm stiffener - Up-
per Front - Left/Right - 2 pcs

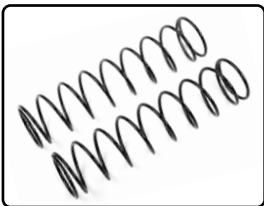

C-00180-286
Shock Spring - Soft - Rear
- 2 pcs

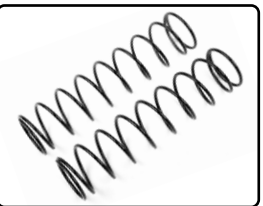

C-00180-287
Shock Spring - Medium - Rear
- 2 pcs

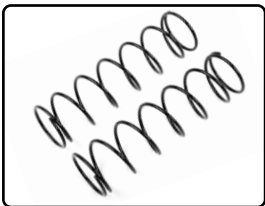

C-00180-289
Shock Spring - Soft - Front
- 2 pcs

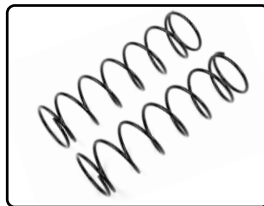

C-00180-290
Shock Spring - Medium - Front
- 2 pcs



C-00180-410
Xtreme Diff Case - 30mm -
FR / RE - Made in Italy - 1 pc



C-00180-854
Gearbox Case Set - Swiss Made
7075 T6 - Black - Set

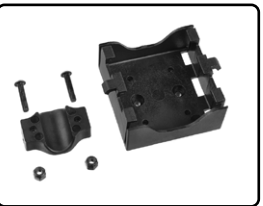

C-00180-835
Centre Roll Cage Foam - Thick-
ness 25mm



C-00180-157
Wing Washer - Lightened -
Aluminium - 2 pcs

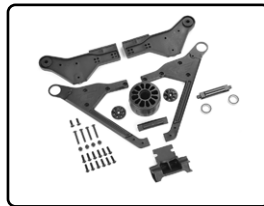

C-00180-567
Wheelie Bar 2021 - 1 Wheel
version - Complete Set



C-00180-612
Off-Road 1/8 MT Tires - Glued
on Black Rims - 1 pair



C-00180-1044
Chassis - MT23 - Swiss Made
7075 T6 - 3mm

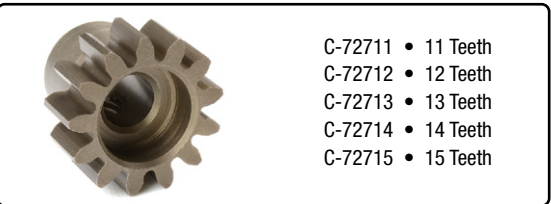

M1.0 Pinion - Hardened Steel - Shaft Diameter 5mm

- C-72711 • 11 Teeth
- C-72712 • 12 Teeth
- C-72713 • 13 Teeth
- C-72714 • 14 Teeth
- C-72715 • 15 Teeth



C-54055
Brushless Motor - Kuron 825 -
4-Pole - 2050 KV - Sensorless



C-54011
Speed Controller - TOROX 185 -
Brushless - 2-6S



C-52022
Digital Servo - CRHV-7225-MG
- High Voltage - Metal Gear



C-52005
Digital Servo - CS-5245 - High
Voltage - Coreless Motor -
Steel Gear - 45 Kg Torque



C-52015
OC-27 HV Digital Servo - Core
DC Motor - Steel Gear - Ball
Beared - Full Alloy Case



C-49164-X
Sport Racing 50C - 4500Mah - 6S
- 22,2V - XT-90 - Hard Case



C-49145-X
Sport Racing 50C - 5400Mah - 4S
- 14,8V - XT-90 - Hard Case



C-49146-X
Sport Racing 50C - 6700Mah - 4S
- 14,8V - XT-90 - Hard Case

STEEL SCREWS - VISSERIE ACIER • STAHSCHRAUBEN • STAAL SCHROEVEN

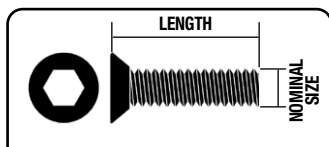

**HEX FLAT HEAD SCREWS
DIN 7991 - STEEL - 10 PCS**

REF	NOMINAL SIZE	LENGTH MM
C-3002-25-06	M2.5	6
C-3002-25-08	M2.5	8
C-3002-25-10	M2.5	10
C-3002-25-12	M2.5	12
C-3002-25-16	M2.5	16
C-3002-25-18	M2.5	18
C-3002-25-20	M2.5	20
C-3002-30-06	M3	6
C-3002-30-08	M3	8
C-3002-30-10	M3	10
C-3002-30-12	M3	12
C-3002-30-14	M3	14
C-3002-30-16	M3	16
C-3002-30-18	M3	18
C-3002-30-20	M3	20
C-3002-30-25	M3	25
C-3002-30-35	M3	35
C-3002-40-08	M4	8
C-3002-40-10	M4	10
C-3002-40-12	M4	12
C-3002-40-14	M4	14
C-3002-40-16	M4	16
C-3002-40-18	M4	18
C-3002-40-20	M4	20
C-3002-40-25	M4	25
C-3002-40-30	M4	30

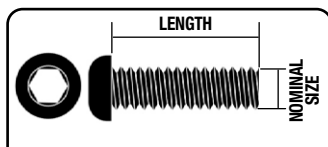

**HEX BUTTON HEAD SCREWS
DIN 7380 - STEEL - 10 PCS**

REF	NOMINAL SIZE	LENGTH MM
C-3003-25-06	M2.5	6
C-3003-25-08	M2.5	8
C-3003-25-10	M2.5	10
C-3003-25-12	M2.5	12
C-3003-25-16	M2.5	16
C-3003-25-18	M2.5	18
C-3003-25-20	M2.5	20
C-3003-30-06	M3	6
C-3003-30-08	M3	8
C-3003-30-10	M3	10
C-3003-30-12	M3	12
C-3003-30-14	M3	14
C-3003-30-16	M3	16
C-3003-30-18	M3	18
C-3003-30-20	M3	20
C-3003-30-25	M3	25
C-3003-30-35	M3	35
C-3003-40-08	M4	8
C-3003-40-10	M4	10
C-3003-40-12	M4	12
C-3003-40-14	M4	14
C-3003-40-16	M4	16
C-3003-40-18	M4	18
C-3003-40-20	M4	20
C-3003-40-25	M4	25
C-3003-40-30	M4	30

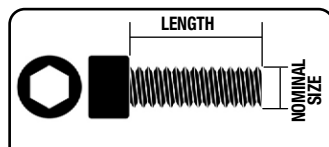

**HEX SOCKET HEAD SCREWS
DIN 912 - STEEL - 10 PCS**

REF	NOMINAL SIZE	LENGTH MM
C-3000-25-06	M2.5	6
C-3000-25-08	M2.5	8
C-3000-25-10	M2.5	10
C-3000-25-12	M2.5	12
C-3000-25-16	M2.5	16
C-3000-25-18	M2.5	18
C-3000-25-20	M2.5	20
C-3000-30-06	M3	6
C-3000-30-08	M3	8
C-3000-30-10	M3	10
C-3000-30-12	M3	12
C-3000-30-14	M3	14
C-3000-30-16	M3	16
C-3000-30-18	M3	18
C-3000-30-20	M3	20
C-3000-30-25	M3	25
C-3000-30-35	M3	35
C-3000-40-08	M4	8
C-3000-40-10	M4	10
C-3000-40-12	M4	12
C-3000-40-14	M4	14
C-3000-40-16	M4	16
C-3000-40-18	M4	18
C-3000-40-20	M4	20
C-3000-40-25	M4	25
C-3000-40-30	M4	30

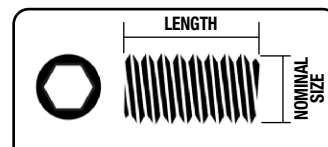

**HEX SET SCREWS
DIN 916 - STEEL - 10 PCS**

REF	NOMINAL SIZE	LENGTH MM
C-3004-30-03	M3	3
C-3004-30-05	M3	5
C-3004-30-08	M3	8
C-3004-30-10	M3	10
C-3004-30-12	M3	12
C-3004-30-20	M3	20
C-3004-40-04	M4	4
C-3004-40-06	M4	6
C-3004-40-08	M4	8
C-3004-40-10	M4	10
C-3004-40-12	M4	12
C-3004-50-04	M5	4
C-3004-50-05	M5	5

TITANIUM SCREWS - VISSERIE TITANE • TITANIUMSCHRAUBEN • TITANIUM SCHROEVEN

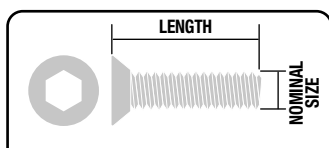

**HEX FLAT HEAD SCREWS
TITANIUM - 10 PCS**

REF	NOMINAL SIZE	LENGTH MM
C-3022-30-06	M3	6
C-3022-30-08	M3	8
C-3022-30-10	M3	10
C-3022-30-12	M3	12
C-3022-30-14	M3	14
C-3022-30-16	M3	16
C-3022-30-18	M3	18
C-3022-30-20	M3	20
C-3022-40-08	M4	8
C-3022-40-10	M4	10
C-3022-40-12	M4	12
C-3022-40-16	M4	16
C-3002-40-20	M4	20

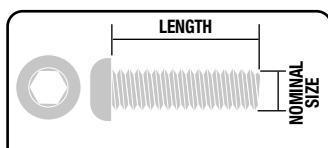

**HEX BUTTON HEAD SCREWS
TITANIUM - 10 PCS**

REF	NOMINAL SIZE	LENGTH MM
C-3023-30-06	M3	6
C-3023-30-08	M3	8
C-3023-30-10	M3	10
C-3023-30-12	M3	12
C-3023-30-16	M3	16
C-3023-30-20	M3	20
C-3023-30-25	M3	25
C-3023-40-06	M4	6
C-3023-40-08	M4	8
C-3023-40-10	M4	10
C-3023-40-12	M4	12
C-3023-40-16	M4	16
C-3023-40-20	M4	20
C-3023-40-25	M4	25

NUTS - ECROUS • MUTTERN • MOEREN

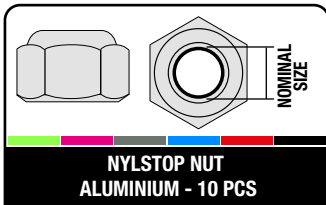

NYLSTOP NUT
ALUMINIUM - 10 PCS

REF	NOMINAL SIZE	COLOR
C-3106-20-0	M2	Gold
C-3106-20-1	M2	Green
C-3106-20-2	M2	Purple
C-3106-20-3	M2	Gun
C-3106-20-4	M2	Blue
C-3106-20-5	M2	Red
C-3106-20-6	M2	Black
C-3106-30-0	M3	Gold
C-3106-30-1	M3	Green
C-3106-30-2	M3	Purple
C-3106-30-3	M3	Gun
C-3106-30-4	M3	Blue
C-3106-30-5	M3	Red
C-3106-30-6	M3	Black
C-3106-40-0	M4	Gold
C-3106-40-1	M4	Green
C-3106-40-2	M4	Purple
C-3106-40-3	M4	Gun
C-3106-40-4	M4	Blue
C-3106-40-5	M4	Red
C-3106-40-6	M4	Black
C-3106-50-0	M5	Gold
C-3106-50-1	M5	Green
C-3106-50-2	M5	Purple
C-3106-50-3	M5	Gun
C-3106-50-4	M5	Blue
C-3106-50-5	M5	Red
C-3106-50-6	M5	Black

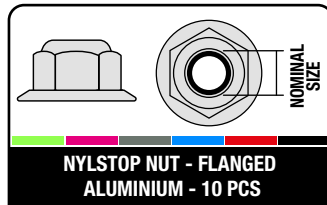

NYLSTOP NUT - FLANGED
ALUMINIUM - 10 PCS

REF	NOMINAL SIZE	COLOR
C-3107-30-0	M3	Gold
C-3107-30-1	M3	Green
C-3107-30-2	M3	Purple
C-3107-30-3	M3	Gun
C-3107-30-4	M3	Blue
C-3107-30-5	M3	Red
C-3107-30-6	M3	Black
C-3107-40-0	M4	Gold
C-3107-40-1	M4	Green
C-3107-40-2	M4	Purple
C-3107-40-3	M4	Gun
C-3107-40-4	M4	Blue
C-3107-40-5	M4	Red
C-3107-40-6	M4	Black
C-3107-50-0	M5	Gold
C-3107-50-1	M5	Green
C-3107-50-2	M5	Purple
C-3107-50-3	M5	Gun
C-3107-50-4	M5	Blue
C-3107-50-5	M5	Red
C-3107-50-6	M5	Black

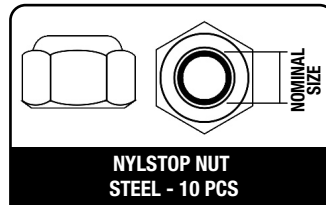

NYLSTOP NUT
STEEL - 10 PCS

REF	NOMINAL SIZE	COLOR
C-3101-20-6	M2	Black
C-3101-25	M2.5	Silver
C-3101-25-6	M2.5	Black
C-3101-30	M3	Silver
C-3101-30-6	M3	Black
C-3101-40	M4	Silver
C-3101-40-6	M4	Black

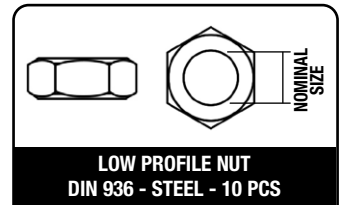

LOW PROFILE NUT
DIN 936 - STEEL - 10 PCS

REF	NOMINAL SIZE	COLOR
C-3104-40	M4	Silver
C-3104-50	M5	Silver

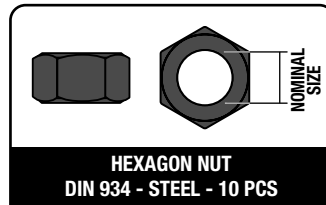

HEXAGON NUT
DIN 934 - STEEL - 10 PCS

REF	NOMINAL SIZE	COLOR
C-3103-20-6	M2	Black
C-3103-25-6	M2.5	Black
C-3103-30-6	M3	Black
C-3103-40-6	M4	Black
C-3103-50-6	M5	Black

BALL BEARINGS

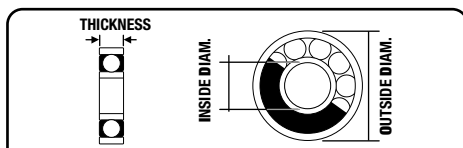

BALL BEARING
ABEC 3 - STEEL - 2 PCS

REF	ID MM	OD MM	TH MM
C-3611-3-05-08-03	5	8	3
C-3611-3-05-10-04	5	10	4
C-3611-3-06-10-03	6	10	3
C-3611-3-08-16-05	8	16	5
C-3611-3-10-15-04	10	15	4
C-3611-3-12-21-05	12	21	5

SHIMS

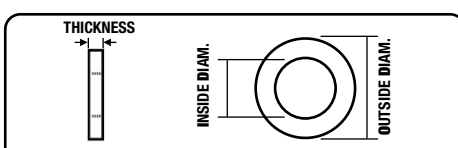

SHIM WASHERS
METRIC - STEEL - 10 PCS

REF	ID MM	OD MM	TH MM
C-3301-04-06-01	4	6	0.1
C-3301-06-08-01	6	8	0.1
C-3301-08-10-01	8	10	0.1
C-3301-13-16-01	13	16	0.1

STEELWASHERS

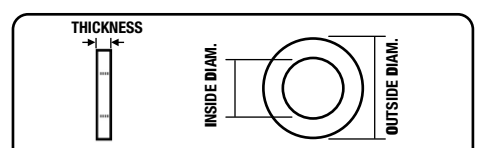

STEEL WASHERS
GALVANIZED STEEL - 10 PCS

REF	ID MM	OD MM	TH MM
C-3201-30	3.2	7	0.5
C-3201-40	4.3	9	0.8
C-3201-60	6.4	12	1.6

FACTORY PRO TOOL



Factory Pro Tool - Hardened Tip - Alu Grip - Hex

TEAM CORALLY - SHOCK PLIERS

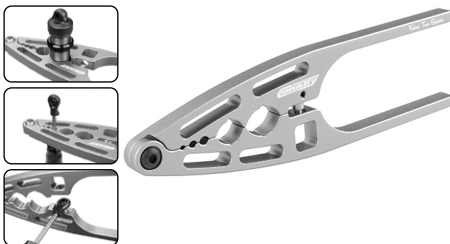

Team Corally - Shock Pliers

PINION CADDY M1.0

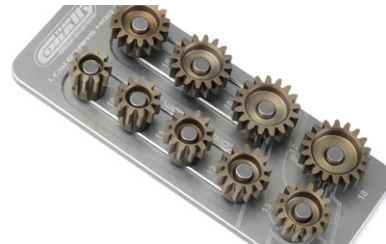

Team Corally - Pinion Caddy M1.0 - 9 Pinions - ø5mm

TEAM CORALLY - GREASE



Lithium Grease - Blue Grease - Ball Diff Grease - Copper Grease

TEAM CORALLY - SILICONE OILS



Shock Oils 60ml - 150ml - CST or WT - 100 >1000 CPS
Diff Oils 60ml - 2000 >2 000 000 CPS

TEAM PIT GEAR



A range of quality equipment for the transport and protection of your equipment.

TEAM CORALLY - PINIONS



Discover our range of Precision CNC-Cut MOD-1.0 Pinions for motors with a ø 5.0mm motor shaft

SPORT RACING - LIPO



Team Corally - Sport Racing 50C - 4S or 6S - XT-90 - Hard Case

ELECTRONIC

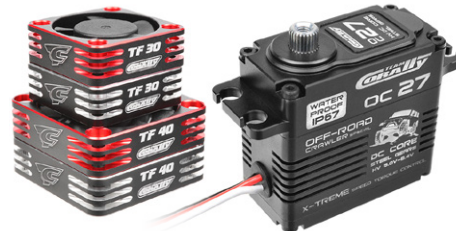

A range of high quality electronic equipment for the best performance.



Discover all these products and more on the website www.corally.com
Découvrez tous ces produits et bien plus encore sur le site web www.corally.com
 Entdecken Sie all diese Produkte und mehr auf der Website www.corally.com
 Ontdek al deze producten en meer op de website www.corally.com

**Discover our range of practical plastic boxes
with a selection of the most commonly used Screws, Nuts, Shims, Washers.**



C-38500
Screw Set M3 - Hex Button Head - DIN 7380 - Steel Black - 10.9 Grade - 15 Sizes - 375 pcs



C-38501
Screw Set M4 - Hex Button Head - DIN 7380 - Steel Black - 10.9 Grade - 15 Sizes - 265 pcs



C-38505
Screw Set M3 - Hex Flat Head - DIN 7991 - Steel Black - 10.9 Grade - 15 Sizes - 375 pcs



C-38506
Screw Set M4 - Hex Flat Head - DIN 7991 - Steel Black - 10.9 Grade - 15 Sizes - 265 pcs



C-38510
Screw Set M3 - Hex Socket Head - DIN 912 - Steel Black - 12.9 Grade - 15 Sizes - 375 pcs



C-38511
Screw Set M4 - Hex Socket Head - DIN 912 - Steel Black - 12.9 Grade - 15 Sizes - 265 pcs



C-38515
Screw Set - Set Screws - M3 - M4 - M5 - DIN 916 - Steel Black - 12.9 Grade - 10 Sizes - 370 pcs



C-38516
Nuts - Lock Nuts - Washers Set - M2 - M2.5 - M3 - M4 - Steel Black - 10 Sizes - 320 pcs



970 pcs

C-38516
Universal Sport Car Series - Screws - Nuts Set - 34 Sizes - 970 pcs



C-38520
Shim Ring Set - Steel - 15 Sizes - 375 pcs

More info

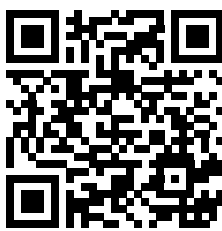

www.corally.com

DECLARATION OF CONFORMITY
EU-Konformitätserklärung/ Déclaration de Conformité UE

(in accordance with ISO/IEC 17050-1) / (in Übereinstimmung mit ISO/IEC 17050-1) /
 (Conformément à la norme ISO/IEC 17050-1)

Description : **KAGAMA XP 6S - ROLLER - MONSTER TRUCK 4WD - 1/8 -RTR**
 Item Number: **C-00474**

This declaration is issued under the sole responsibility of the manufacturer.
 Die alleinige Verantwortung für die Ausstellung dieser Erklärung trägt der Hersteller.
 La présente déclaration est établie sous la seule responsabilité du fabricant.

Product(s)/Produkt(e)/ Produit(s) : **KAGAMA XP 6S - ROLLER - MONSTER TRUCK 4WD - 1/8 -RTR**

The object of declaration described above is in conformity with the relevant Union harmonization Legislation, specifically the requirements of the specifications listed below, following the provisions of the European RED Directive 2014/53/EU:
 Der Gegenstand dieser Erklärung ist konform mit den Harmonisierungsrechtsvorschriften der Europäischen Union, insbesondere mit den unten aufgeführten Bestimmungen, und folgt der europäischen RED Direktive 2014/53/EU:
 L'objet de la déclaration décrit ci-dessus est conforme à la législation pertinente en matière d'harmonisation de l'Union européenne, en particulier les exigences des spécifications énumérées ci-dessous, conformément aux dispositions des directives européennes RED 2014/53/EU:

EN 300 440 V2.1.1:2017	EN 301 489-3 V1.6.1:2013
EN 301 489-1 V2.1.1:2017	EN 60950-1:2006+A11:2009+A1:2010+A12:2011+A2:2013
EN 62479:2010	EN 55024:2010+A1:2015
EN 55032:2015	EN 61000-3-3:2013
EN 61000-3-2:2014	

JSP GROUP INTL • Geelseweg, 80 • 2250 Olen • Belgium

Signed for and on behalf of/ Unterzeichnet für und im Namen von/ Signé pour et au nom de :

Place/Ort/Lieu and Date/Datum/Data : **Olen, Belgium, 22 March 2023**

Name/Nom: **Stefan Engelen**
 Title/Titel/Titre : **Ceo**

Signature/Unterschrift :



WWW.CORALLY.COM

TEAM
CORALLY

WORLD CHAMPIONS



WWW.CORALLY.COM

Team Corally is a registered trademark licensed to
JSP Group Intl bvba • Geelseweg 80 • B-2250 OLEN • Belgium
Tel: +32 14 25 92 94 • Info@corally.com